

Mechanical ventilation systems with heat recovery

Vitoair FS	Centralised	Ceiling/wall mounted unit	300 m³/h	5.1
Vitovent 300-W	Centralised	Wall mounted unit	225 to 600 m³/h	5.2
Ductwork				5.3

Decentralised ventilation units with heat recovery

Vitovent 050-D	Decentralised	Wall integration	43 m³/h	5.4
Vitovent 100-D	Decentralised	Wall integration	45 m³/h	5.5
Vitovent 200-D	Decentralised	Wall integration	55 m³/h	5.6

Filters for ventilation units				5.7
-------------------------------	--	--	--	------------

Viessmann's integrated range of solutions

Digital services



Connectivity and platforms

Products & systems

- VITOAIR FS**
 - VITOVENT 050-D**
 - VITOVENT 300-W**
 - VITOVENT 100-D**
 - VITOVENT 200-C**
 - VITOVENT 200-D**
- Ductwork
Filters

		Vitoair FS Type 300E MA	Vitovent 300-W Type H32S A225	Vitovent 300-W Type H32S C325	Vitovent 300-W Type H32S C400
Mechanical ventilation system		Wall mounted/ ceiling mounted	Wall mounted		
Application		Newly built single/two- family house	Newly built single/ two-family house		
Max. flow rate	[m ³ /h]	300	225	325	400
Standard value for max. ventilated nominal area at rated output	[~ m ²]	320	160	320	440
Standard value for max. number of people					

5





Functions

Constant flow rate control	X	X
Ventilation levels	Continuous	Continuous
Automatic bypass (100 %)	X	X
Electric preheating coil	□	X
Filters	Coarse filters ^{*1}	Coarse filters ^{*1}
Filter change indicator	X	X
Demand-dependent filter monitoring	X	X
Certified according to the criteria of the Passive House Institute	X	X

^{*1}Fine filters in Accessories

X Applicable
□ Accessories

Control modes for mechanical ventilation systems to ErP (symbols)

-  **Manual control** (on/off and step switch)
-  **Time control** (via time switch, time programs)
-  **Central demand control** (central capturing of air data in addition to time control or manual control)
-  **Control according to local demand** (capturing of multiple air data in addition to time control or manual control)

VITOAIR FS

Mechanical ventilation system with heat recovery
Wall or ceiling mounted

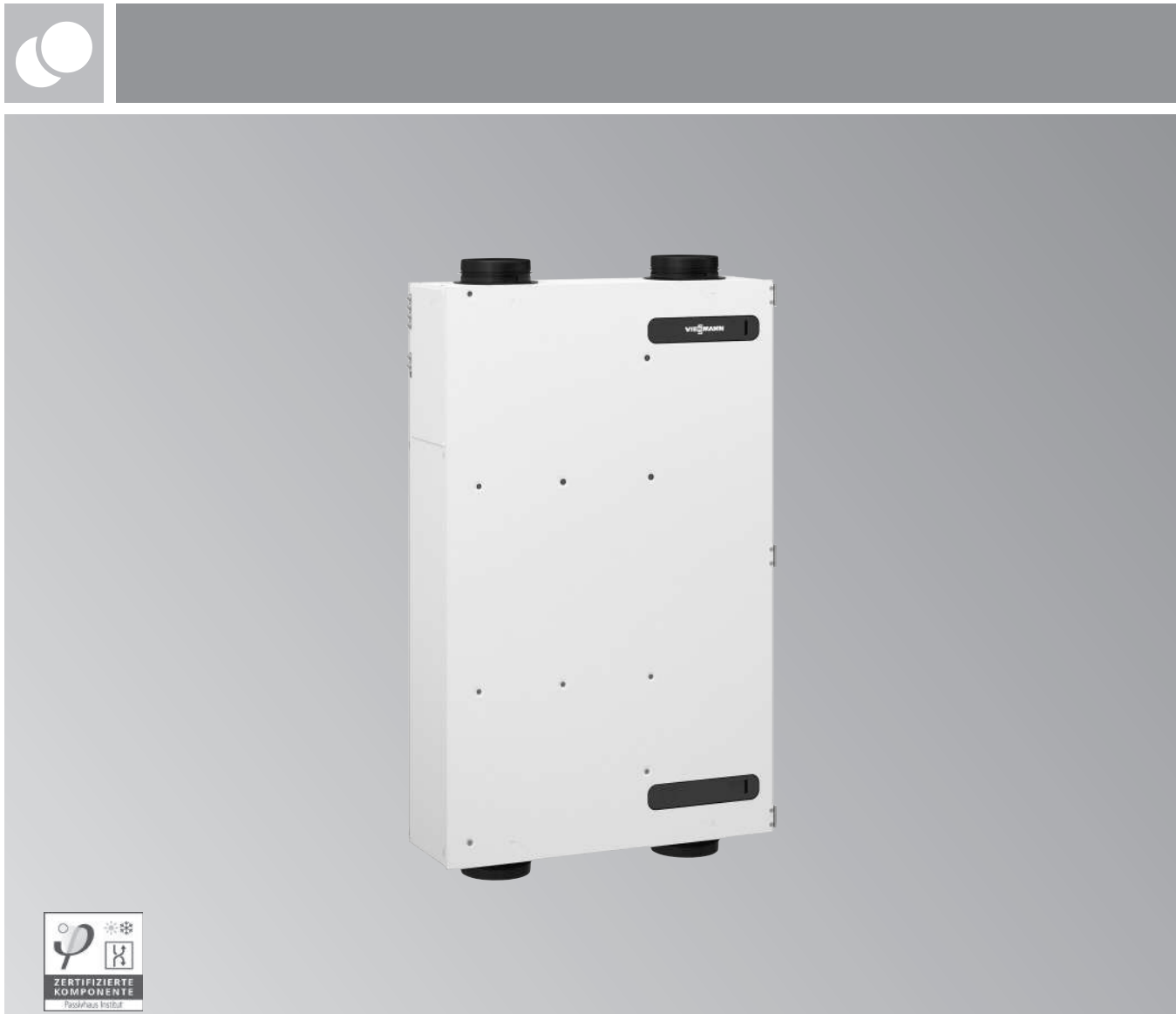

5.1

Vitoair FS

Mechanical ventilation systems with heat recovery, for demand-dependent mechanical ventilation with purified and heated outdoor air



Up to 300 m³/h with integral bypass circuit and enthalpy heat exchanger for additional humidity control

Demand-dependent flow rate control via ViCare, the Vitocal control unit or digital programming unit

- Ensures thermal comfort and a healthy room climate.
- Reduced odour nuisance
- Convenient operation via the ViCare app, the Vitocal control unit and the use of common accessories
- Alternatively, operation via a separate programming unit (accessories)
- Balanced humidity management prevents building damage.
- Increased protection against burglary and noise as windows can be kept closed
- Filtered outdoor air – important for allergy sufferers
- Economical DC fans with a constant flow rate and balance control keep the air flow constant, independent of the static pressure.
- Very high heat recovery level minimises ventilation heat losses and lowers heating bills.
- No condensate drain required
- Little space required due to low installed height
- Flexible positioning: Ceiling mounting, wall mounting, floorstanding installation
- Connector arrangement can be changed on site.
- Humidity control to prevent dry air in winter.

VITOAIR FS

Ventilation units with heat recovery
- Wall or ceiling mounted



Ventilation units		300E MA	MG WV
Type Vitoair FS Central mechanical ventilation unit with heat recovery and humidity control, air flow rate up to 300 m³/h. <ul style="list-style-type: none"> ■ For residential units with up to approx. 280 m² living space ■ Connector arrangement can be changed on site ■ 4 connectors DN 160 for outdoor air, supply air, extract air and exhaust air ■ Wall, floor and ceiling mounting possible ■ Balance control ■ Constant flow rate control with impeller air speed meter ■ Modular summer bypass (up to 100 %) ■ Humidity control through integral enthalpy heat exchanger ■ Integral WiFi interface for commissioning via ViGuide and operation via ViCare ■ Including mounting rail and bracket 		 Z023297 3.491,- <A> <A> <A> <A>	Part no. Euro 
5.1	Specification		
	Air flow rate	300	m³/h
	Type of heat exchanger	X	
	Type of filter (supply air/extract air) <ul style="list-style-type: none"> ■ Standard delivery ■ Accessories 	G4/G4 F7/G4	
	Heat recovery	Up to 80	%
	Humidity control	Up to 74	%
	Length	1254	mm
	Height	240	mm
	Width	800	mm
	Condensate drain	X	
	<ul style="list-style-type: none"> ■ Not required 		
	Passive House Institute certified component	X	
	Package Vitoair FS with Electric preheating coil Electric preheating coil has to be installed separately		Z025382 3.703,-

Notes on filter type:
 G4 = ISO Coarse 60 %
 F7 = ISO ePM1 50 %

5472794
5472701

VITOAIR FS

Ventilation units with heat recovery
- Wall or ceiling mounted





Accessories			
Bus cables			MG WX
Bus cable, length 5 m Fully wired, shielded CAN bus cable for networking bus subscribers in the system network, e.g. Vitoair, Vitocal, Vitocharge, etc.		ZK06219 58,-	Part no. Euro
Bus cable, length 15 m Fully wired, shielded CAN bus cable for networking bus subscribers in the system network, e.g. Vitoair, Vitocal, Vitocharge, etc.		ZK06220 112,-	Part no. Euro
Bus cable, length 30 m Fully wired, shielded CAN bus cable for networking bus subscribers in the system network, e.g. Vitoair, Vitocal, Vitocharge, etc.		ZK06221 204,-	Part no. Euro
Remote control units			MG W
Vitotrol 300-E Multi-system wireless remote control for supporting various heat generators (e.g. Vitodens, Vitocal and Vitovalor) or mechanical ventilation systems (Vitoair). <ul style="list-style-type: none"> ■ Wireless communication with the heat generator via low power radio ■ Backlit graphic display ■ Display of room temperature and room humidity ■ Depending on the connected system: Support for heating, cooling and ventilation operating modes ■ Room views in combination with individual room control ■ Setting of various operating modes or time programs ■ Intuitive colour-coded user navigation (Lightguide) <i>To extend the range of the wireless signal, the Viessmann ViCare repeater or the wireless repeater for flush mounting can be used.</i> <i>If the Vitotrol 300-E is to have a flush mounted power supply, a power supply unit for flush mounting must also be ordered.</i> <ul style="list-style-type: none"> ■ <i>No more than one Vitotrol 300-E per heating circuit/cooling circuit or per mechanical ventilation system may be installed.</i> ■ <i>Mixed operation with a Vitotrol 200-E is not possible.</i> <i>For a precise summary of compatibility see www.vitotrol.info</i>		7959522 419,-	Part no. Euro
Power supply unit for flush mounting As an alternative to the plug-in power supply unit provided, the Vitotrol 300-E can also be supplied with power via the power supply unit for flush mounting. The power supply unit for flush mounting fits in a commercially available flush box. <ul style="list-style-type: none"> ■ Power supply unit with 12 V/500 mA output power ■ As per EUP Directive 2005/32/EC ■ Input and output via screw terminals ■ Dimensions 54 x 26 mm 		ZK03842 69,-	Part no. Euro MG Y
Remote control units for the ventilation unit			MG WV
4-level pushbutton Hardwired 4-level pushbutton <ul style="list-style-type: none"> ■ Fan stages 1 to 4 manually selectable ■ Filter change indicator 		7372092 246,-	Part no. Euro

5.1

VITOAIR FS

Ventilation units with heat recovery
- Wall or ceiling mounted



5.1

Accessories			
Wireless accessories			MG Y
<p>ViCare climate sensor – temperature and humidity sensor (low power radio)</p> <p>Battery operated temperature and humidity sensor for monitoring the room climate. The sensor can be connected to the Vitoair FS mechanical ventilation system, a heat generator with integral communication module or a Vitoconnect.</p> <ul style="list-style-type: none"> ■ The ViCare climate sensor captures the temperature and the relative humidity in the room. ■ In rooms with ViCare thermostatic radiator valves or ViCare floor thermostats, the ViCare climate sensor enables precise individual room control. <p>Standard delivery:</p> <ul style="list-style-type: none"> ■ ViCare climate sensor ■ Battery, button cell CR2450, 600 mAh ■ Installation material for wall mounting <p><i>A climate sensor is required for each heating zone when combined with the ViCare floor thermostat. We recommend ViCare climate sensors if using ViCare thermostatic radiator valves in very large rooms.</i></p>		ZK03839 54,-	Part no. Euro
<p>ViCare repeater for surface mounting (low power radio)</p> <ul style="list-style-type: none"> ■ Extension of the low power radio network for better connection of the ViCare components. <p>Standard delivery:</p> <ul style="list-style-type: none"> ■ 1 ViCare climate sensor ■ 1 plug-in power supply unit with power cable ■ Installation material for wall mounting <p><i>A ViCare repeater consists of a ViCare climate sensor without installed battery and a plug-in power supply unit. The ViCare repeater can be set up directly as a repeater in the ViCare app. Battery operation not possible. Socket required near the installation site.</i></p>		ZK05390 121,-	Part no. Euro
<p>Repeater for flush mounting (low power radio)</p> <ul style="list-style-type: none"> ■ For forwarding data in large buildings ■ Installation in commercially available flush box. Deep flush box if being mounted behind a switch or socket. <p>Standard delivery:</p> <ul style="list-style-type: none"> ■ Wireless repeater ■ Connection material <p><i>The wireless repeater can be set up directly as a wireless repeater in the ViCare app.</i></p>		ZK05462 111,-	Part no. Euro
Accessories			MG WV
<p>Electric preheating coil</p> <p>For installation in the ventilation unit</p> <ul style="list-style-type: none"> ■ Additional preheating coil for continuous balanced operation of the ventilation unit when outside temperatures are very low ■ Fully wired. ■ Up to max. 1.8 kW 		7372079 621,-	Part no. Euro
<p>Compact outdoor air or exhaust air outlet</p> <ul style="list-style-type: none"> ■ For routing air via the installation wall ■ EPP pipe and female connection ■ External wall outlet, white, with bird guard 		ZK01840 365,-	Part no. Euro

5472794
5472704

VITOAIR FS

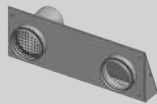
Ventilation units with heat recovery
- Wall or ceiling mounted

Accessories			
Outdoor air and exhaust air apertures			MG WV
Combi external wall grille <ul style="list-style-type: none"> ■ Combined outdoor and exhaust air outlet in one element ■ With wall outlet, DN 160 ■ Distance between axes: 470 mm ■ Colour/material: Stainless steel 		7377409 457,- Part no. Euro	
Filters for Vitoair FS			MG WV
ViPure fine filter set for ventilation unit Set for 1 filter change <ul style="list-style-type: none"> ■ 1 supply air filter F7 / ISO ePM1 50 % ■ 1 extract air filter G4 / ISO Coarse 60 % 		7372093 77,- Part no. Euro	
ViPure coarse filter set for ventilation unit Set for 1 filter change <ul style="list-style-type: none"> ■ 1 supply air filter G4 / ISO Coarse 60 % ■ 1 extract air filter G4 / ISO Coarse 60 % 		7372082 69,- Part no. Euro	

5.1

5.1

VITOVENT 300-W

Mechanical ventilation system with heat recovery
- Wall mounted



5.2

Vitovent 300-W

Mechanical ventilation systems with heat recovery and humidity control, for demand-dependent mechanical ventilation with purified and heated outdoor air

Vitovent 300-W to 225 m³/h, 325 m³/h, 400 m³/h or 600 m³/h with integral bypass circuit and electric preheating coil

Vitovent 300-W enthalpy version with air flow rates up to 325 m³/h and 400 m³/h for additional humidity control

Demand-dependent flow rate control via Vitocal control unit or digital programming unit and sensors (optional)

- Ensures thermal comfort and a healthy room climate.
- Reduced odour nuisance
- Convenient operation with the Vitotronic 200 control unit of the Vitocal and use of common accessories
- Alternatively, operation via a separate programming unit (accessories)
- Full parameter setting via digital programming unit
- Balanced humidity management prevents building damage
- Increased protection against burglary and noise as windows can be kept closed
- Filtered outdoor air – important for allergy sufferers
- Economical DC motors with a constant flow rate and balance control maintain a constant air flow, independent of the static pressure.
- Very high heat recovery level minimises ventilation heat losses and lowers heating bills.

4/2023

5853556

VITOVENT 300-W

Ventilation units with heat recovery

- Air flow rate 225 and 325 m³/h

- Cross-counter-current heat exchanger

Ventilation units

Type

Vitovent 300-W

Central mechanical ventilation unit with heat recovery

- Right-hand version (R) with supply air and extract air connections on right side, left-hand version (L) with supply air and extract air connections on left side
- 4 connectors for outdoor air, supply air, extract air and exhaust air
- Wall mounted (vertical installation with accessories)
- Balance control
- Constant flow rate control
- Summer bypass (100 %)
- Integral electric preheating coil (demand-dependent control)
- Waterless trap

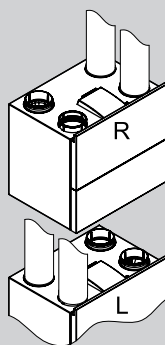

A programming unit **must** also be ordered to operate the Vitovent.

H32S A225 (R)	H32S A225 (L)	H32S C325 (R)	H32S C325 (L)
Z021837	Z021838	Z019040	Z019041
2.208,-	2.208,-	2.467,-	2.473,-
—	—	—	—
<A>	<A>	<A>	<A>
<A+>	<A+>	<A+>	<A+>
<A+>	<A+>	<A+>	<A+>

MG WV

Part no.
Euro



5.2

Specification

Type

	H32S A225 (R)	H32S A225 (L)	H32S C325 (R)	H32S C325 (L)	
Air flow rate	225	225	325	325	m ³ /h
Living space approx.	160	160	320	320	m ²
Type of heat exchanger	Cross-counter-current				
4 connectors	DN 125	DN 125	DN 160	DN 160	
Output of electric preheating coil	0.7	0.7	1.0	1.0	kW
Type of filter (outdoor air/extract air)	G4/G4 F7/G4	G4/G4 F7/G4	G4/G4 F7/G4	G4/G4 F7/G4	
Heat recovery	Up to 94	Up to 94	Up to 98	Up to 98	%
Length (depth)	455	455	560	560	mm
Height	650	650	650	650	mm
Width	600	600	750	750	mm
Passive House Institute certified component	X	X	X	X	

Notes on filter type:

G4 = ISO Coarse 60 %

F7 = ISO ePM1 50 %

M5 = ISO ePM10 50 %

5853556
5853556

VITOVENT 300-W

Ventilation units with heat recovery
 - Air flow rate 400 and 600 m³/h
 - Cross-counter-current heat exchanger

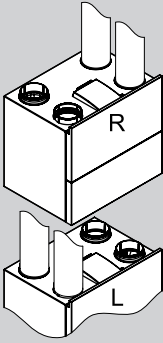
Ventilation units		H32S C400 (L)	H32S C400 (R)	H32S A600 (R)	H32S A600 (L)	MG WV
Type		Z019043	Z019042	Z026465	Z026466	Part no.
Vitovent 300-W		2.713,-	2.713,-	3.929,-	3.929,-	Euro
Central mechanical ventilation unit with heat recovery		-	-	-	-	⊕
<ul style="list-style-type: none"> Right-hand version (R) with supply air and extract air connections on right side, left-hand version (L) with supply air and extract air connections on left side 4 connectors for outdoor air, supply air, extract air and exhaust air For 600 m³/h version only: 4 reducers to DN 180 Wall mounted (vertical installation with accessories) Balance control Constant flow rate control Summer bypass (100 %) Integral electric preheating coil (demand-dependent control) Waterless trap 		<A>	<A>	<A>	<A>	⊖
		<A+>	<A+>	<A+>	<A+>	⊕
		<A+>	<A+>	<A+>	<A+>	⊕
A programming unit must also be ordered to operate the Vitovent.						

5.2

Specification		H32S A400 (R)	H32S A400 (L)	H32S C600 (R)	H32S C600 (L)	
Type						
Air flow rate		400	400	600	600	m³/h
Living space approx.		440	440	750	750	m²
Type of heat exchanger		Cross-counter-current				
4 connectors		DN 180	DN 180	DN 200	DN 200	
Output of electric preheating coil		1.0	1.0	1.0	1.0	kW
Type of filter (outdoor air/extract air)	<ul style="list-style-type: none"> Standard delivery Accessories 	G4/G4 F7/G4	G4/G4 F7/G4	G4/G4 F7/G4	G4/G4 F7/G4	
Heat recovery		Up to 99	Up to 99	Up to 92	Up to 92	%
Length (depth)		560	560	660	660	mm
Height		650	650	800	800	mm
Width		750	750	850	850	mm
Passive House Institute certified component		X	X	X	X	

Notes on filter type:
 G4 = ISO Coarse 60 %
 F7 = ISO ePM1 50 %
 M5 = ISO ePM10 50 %

5853556

VITOVENT 300-W

- Ventilation units with heat recovery and humidity control
- Air flow rate 325 and 400 m³/h
 - Enthalpy heat exchanger

Ventilation units

Type

Vitovent 300-W

Central mechanical ventilation unit with heat recovery and humidity control

- Right-hand version (R) with supply air and extract air connections on right side, left-hand version (L) with supply air and extract air connections on left side
- 4 connectors for outdoor air, supply air, extract air and exhaust air
- Wall mounted (vertical installation with accessories)
- Balance control
- Constant flow rate control
- Summer bypass (100 %)
- Integral electric preheating coil (demand-dependent control)
- Waterless trap

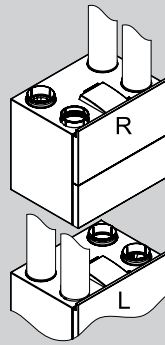

A programming unit **must** also be ordered to operate the Vitovent.

H32E C325 (R)	H32E C325 (L)	H32E C400 (R)	H32E C400 (L)
Z026526 3.209,-	Z026527 3.209,-	Z026528 3.455,-	Z026529 3.455,-
<A>	<A>	<A>	<A>
<A>	<A>	<A>	<A>
<A>	<A>	<A>	<A>
<A*>	<A*>	<A>	<A>

MG WV

Part no.
Euro



5.2

Specification

Type

	H32E C325 (R)	H32E C325 (L)	H32E C400 (R)	H32E C400 (L)	
Air flow rate	325	325	400	400	m ³ /h
Living space approx.	320	320	440	440	m ²
Type of heat exchanger	Enthalpy				
4 connectors	DN 160	DN 160	DN 180	DN 180	
Output of electric preheating coil	1.0	1.0	1.0	1.0	kW
Type of filter (outdoor air/extract air)	G4/G4 F7/G4	G4/G4 F7/G4	G4/G4 F7/G4	G4/G4 F7/G4	
Heat recovery	Up to 98	Up to 98	Up to 99	Up to 99	%
Humidity control	86/77	86/77	84/71	84/71	%
Length (depth)	560	560	560	560	mm
Height	650	650	650	650	mm
Width	750	750	750	750	mm
Passive House Institute certified component	X	X	X	X	

Notes on filter type:

- G4 = ISO Coarse 60 %
F7 = ISO ePM1 50 %
M5 = ISO ePM10 50 %

5853556
5853556

VITOVENT 300-W

Ventilation units with heat recovery
- Wall mounted

Accessories		
<p>Communication technology</p> <p>Vitoconnect V Internet interface for remote control of Vitovent 300-W via the internet using the ViCare app. Vitoconnect V establishes the connection to the internet.</p> <p>Significant product features</p> <ul style="list-style-type: none">■ Operation of the ventilation unit with Vitotrol 300-E and the 4-level pushbutton■ Use of ViCare app and ViGuide■ Connection of climate sensors■ Connection to products with Viessmann One Base <p>Standard delivery</p> <ul style="list-style-type: none">■ Vitoconnect V■ Power cable with plug (2.4 m long)■ Modbus cable (2 m long) <p>Notes!</p> <ul style="list-style-type: none">■ Before commissioning, check the system requirements for communication via the local IP network/WiFi.■ For operating the Vitoconnect, an available internet connection with flat rate data (no time or volume restrictions) is recommended.■ Compatible with types H32S/E A225(R/L), C325(R/L), C400(R/L), A600(R/L)	 <p>Z027169 294,-</p>	<p>MG WV</p> <p>Part no. Euro</p>

5.2

5853556

VITOVENT 300-W

Ventilation units with heat recovery
- Wall mounted

5.2

Accessories							
Programming units							
Type	H32S A225	H32S C325	H32E C325	H32S C400	H32E C400	H32S A600	MG WV
Vitocal/Vitivent connecting cable Connecting cable between Vitivent and Vitotronic 200 control unit, type WO1C (6 m long). <ul style="list-style-type: none"> To operate the Vitivent 200-W/300-W/300-C via the Vitotronic 200 control unit, type WO1C <ul style="list-style-type: none"> - Backlit graphic display with plain text - Time programs with individual day and seven-day program - Program selector - Filter change indicator Common use of control and programming unit accessories <i>Control type to ErP Directive: Time control</i>	ZK02789 45,-					Part no. Euro	
Ventilation programming unit, type LB1 Illuminated, graphic programming unit for Vitivent.  <ul style="list-style-type: none"> Time programs with individual day and seven-day program 4-step switch Program selection Filter change indicator Parameter setting with plain text display Connecting cable, 6 m long <i>Control type to ErP Directive: Time control</i>	Z015318 388,-					Part no. Euro	
Flow rate control accessories							
Type	H32S A225	H32S C325	H32E C325	H32S C400	H32E C400	H32S A600	MG WV
Humidity sensor (central) <ul style="list-style-type: none"> Installation in the extract air duct (header) Operation of the ventilation unit with the minimum required air flow rate for the removal of humidity from the living space Up to 10 % energy savings through automatic control <i>Control type to ErP Directive: Central demand control</i>	ZK02539 377,-					Part no. Euro	
CO₂ sensor, hardwired To control the ventilation unit subject to the CO ₂ concentration. <ul style="list-style-type: none"> Room installation 1 sensor for CO₂ measurement Operation of the ventilation unit with the minimum required air flow rate for the removal of humidity and CO₂ from the living space Up to 10 % energy savings through automatic control <i>Control type to ErP Directive: Central demand control</i>	ZK05282 479,-					Part no. Euro	

5853556
5853556

VITOVENT 300-W

Ventilation units with heat recovery
- Wall mounted

Accessories			
Remote control units			
<p>Vitotrol 300-E Multi-system wireless remote control for supporting various heat generators (e.g. Vitodens, Vitocal and Vitovalor) or mechanical ventilation systems (Vitoair).</p> <ul style="list-style-type: none"> ■ Wireless communication with the heat generator via low power radio ■ Backlit graphic display ■ Display of room temperature and room humidity ■ Depending on the connected system: support for heating, cooling and ventilation operating modes ■ Room views in combination with individual room control ■ Setting of various operating modes or time programs ■ Intuitive colour-coded user navigation (Lightguide) <p><i>To extend the range of the wireless signal, the Viessmann ViCare repeater or the repeater for flush mounting can be used.</i></p> <p><i>If the Vitotrol 300-E is to have a flush mounted power supply, a power supply unit for flush mounting must be added to the order.</i></p> <ul style="list-style-type: none"> ■ No more than 1 Vitotrol 300-E per heating circuit/cooling circuit or per mechanical ventilation system may be installed. ■ Mixed operation with a Vitotrol 200-E is not possible. <p><i>For a precise summary of compatibility see www.vitotrol.info</i></p> <p><i>Can only be used in conjunction with Vitoconnect V.</i></p>		7959522 419,-	Part no. Euro MG W
<p>Power supply unit for flush mounting As an alternative to the plug-in power supply unit provided, power can also be supplied via the power supply unit for flush mounting. The power supply unit for flush mounting fits in a commercially available flush box.</p> <ul style="list-style-type: none"> ■ Power supply unit with 12 V/500 mA power output ■ As per EUP Directive 2005/32/EC ■ Input and output via screw terminals ■ Dimensions 54 x 26 mm 		ZK03842 69,-	Part no. Euro MG Y

5.2



Note!

Accessories for flow rate control and remote control units can be used in parallel with the programming unit.

Remote control units for the ventilation unit			MG WW
<p>4-level pushbutton Hardwired 4-level pushbutton</p> <ul style="list-style-type: none"> ■ Fan levels 1 to 4 manually selectable ■ Filter change indicator <p><i>Can only be used in conjunction with Vitoconnect V.</i></p>		7372092 246,-	Part no. Euro

VITOVENT 300-W



Ventilation units with heat recovery
- Wall mounted

Accessories			
Wireless accessories			MG Y
<p>ViCare climate sensor – temperature and humidity sensor (low power radio) Battery-operated temperature and humidity sensor for monitoring the room climate. The sensor can be connected to the Vitoair FS mechanical ventilation system, a heat generator with integral communication module or a Vitoconnect.</p> <ul style="list-style-type: none"> ■ The ViCare climate sensor captures the temperature and relative humidity in the room. ■ In rooms with ViCare thermostatic radiator valves or ViCare floor thermostats, the ViCare climate sensor enables precise individual room control. <p>Standard delivery:</p> <ul style="list-style-type: none"> ■ ViCare climate sensor ■ Button cell battery CR2450, 600 mAh ■ Installation material for wall mounting <p><i>A climate sensor is required for each heating zone when combined with the ViCare floor thermostat. We recommend ViCare climate sensors if using ViCare thermostatic radiator valves in very large rooms.</i> <i>Can only be used in conjunction with Vitoconnect V.</i></p>		<p>ZK03839 54,-</p>	<p>Part no. Euro</p>
<p>ViCare repeater for surface mounting (low power radio) ■ Extension of the low power radio network for better connection of the ViCare components.</p> <p>Standard delivery:</p> <ul style="list-style-type: none"> ■ 1 ViCare climate sensor ■ 1 plug-in power supply unit with power cable ■ Installation material for wall mounting <p><i>A ViCare repeater consists of a ViCare climate sensor without installed battery and a plug-in power supply unit. The ViCare repeater can be set up directly as a repeater in the ViCare app. Battery operation not possible. Socket required near the installation site.</i> <i>Can only be used in conjunction with Vitoconnect V.</i></p>		<p>ZK05390 121,-</p>	<p>Part no. Euro</p>

5.2

VITOVENT 300-W

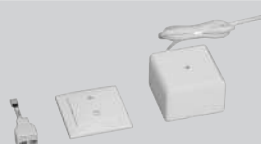
Ventilation units with heat recovery
- Wall mounted

Accessories							
Remote control units							
Type	H32S A225	H32S C325	H32E C325	H32S C400	H32E C400	H32S A600	MG WV
Wireless operating switch with wireless receiver  <ul style="list-style-type: none"> ■ 2-step switch including batteries ■ For temporarily switching the ventilation unit to intensive ventilation ■ Operation of one ventilation unit with up to 6 wireless operating switches parallel to the remote control 	ZK01374 834,-						Part no. Euro
Wireless operating switch without wireless receiver  <p>(A wireless receiver must be available)</p> <ul style="list-style-type: none"> ■ 2-step switch including batteries ■ For temporarily switching the ventilation unit to intensive ventilation ■ Operation of one ventilation unit with up to 6 wireless operating switches parallel to the remote control 	ZK01375 143,-						Part no. Euro
Control and operating accessories If the ventilation unit is connected to the heat generator, accessories can be used to operate the entire system. ► See heat generator control accessories.							

5.2

Notes:

Accessories for flow rate control and remote control units can be used in parallel with the programming unit.



Accessories							
Type	H32S A225	H32S C325	H32E C325	H32S C400	H32E C400	H32S A600	MG WV
Electric preheating coil  <p>Suitable for the ventilation unit connectors.</p> <ul style="list-style-type: none"> ■ Additional preheating coil for continuous balanced operation of the ventilation unit when outside temperatures are very low (application in passive houses) ■ Fully wired. ■ Up to max. 1 kW 	ZK05958 755,-	ZK05283 748,-		ZK05284 776,-			Part no. Euro

5853556

VITOVENT 300-W

Ventilation units with heat recovery
- Wall mounted

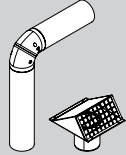
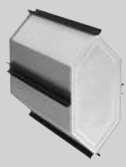

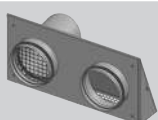
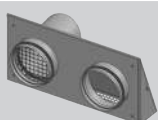
5.2

Accessories							
Accessories							
Type	H32S A225	H32S C325	H32E C325	H32S C400	H32E C400	H32S A600	MG WV
Compact outdoor air or exhaust air outlet <ul style="list-style-type: none"> For routing air via the installation wall. Designed for Vitovent 200-W/300-W. EPP pipe and female connection External wall outlet, white, with bird guard 	-	ZK01840 365,-		ZK01841 375,-			Part no. Euro
Enthalpy heat exchanger <ul style="list-style-type: none"> For the recovery of heat and moisture from the extract air Used instead of the countercurrent heat exchanger which is part of the standard delivery. Can be cleaned (washable) Antibacterial effect Results in a lower freezing limit of the heat exchanger. 	-	ZK05285 1.691,-			7973279 1.374,-		Part no. Euro
Mounting base For floorstanding installation of the Vitovent 200-W/300-W. 	ZK05959 270,-	ZK05286 268,-			7973282 217,-		Part no. Euro
Outdoor air and exhaust air apertures							
Type	H32S A225	H32S C325	H32E C325	H32S C400	H32E C400	H32S A600	MG WV
Combi external wall grille <ul style="list-style-type: none"> Combined outdoor and exhaust air outlet in one element With wall outlet DN 125 Distance between axes: 233.5 mm Colour/material: Stainless steel For direct air routing via the external wall, use the compact 90° bend. 	7377389 402,-				-		Part no. Euro
Combi external wall grille <ul style="list-style-type: none"> Combined outdoor and exhaust air outlet in one element With wall outlet DN 160 Distance between axes: 280 mm Colour/material: Stainless steel For direct air routing via the external wall, use the compact 90° bend. 	-	7377390 459,-				-	Part no. Euro
Combi external wall grille <ul style="list-style-type: none"> Combined outdoor and exhaust air outlet in one element With wall outlet DN 180 Distance between axes: 280 mm Colour/material: Stainless steel For direct air routing via the external wall, use the compact 90° bend. 			-	7377391 487,-			Part no. Euro

5853556
5853556

VITOVENT 300-W

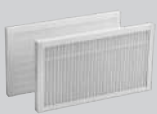
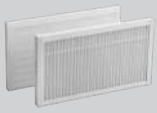
Ventilation units with heat recovery
- Wall mounted

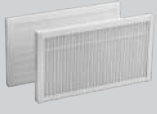
Accessories								
Filter for Vitovent 300-W		H32S A225	H32S C325	H32E C325	H32S C400	H32E C400	H32S A600	MG WV
Type		ZK05956 77,-		-			7973281 46,-	Part no. Euro
ViPure fine filter set for ventilation unit Set for 1 filter change ■ 1 supply air filter F7 / ISO ePM1 50 % ■ 1 extract air filter G4 / ISO Coarse 60 %								
Type		-		ZK05288 63,-			-	Part no. Euro
ViPure fine filter set for ventilation unit with enthalpy heat exchanger Set for 1 filter change ■ 1 supply air filter F7 / ISO ePM1 50 % ■ 1 extract air filter F7 / ISO ePM1 50 %								
Type		ZK05957 51,-		ZK05289 51,-			7973280 25,-	Part no. Euro
ViPure coarse filter set for ventilation unit Set for 1 filter change ■ 1 supply air filter G4 / ISO Coarse 60 % ■ 1 extract air filter G4 / ISO Coarse 60 %								
Filters for Vitovent 300-W		H32S A225	H32S C325	H32E C325	H32S C400	H32E C400	H32S A600	MG WV
Type		-		ZK05287 77,-			-	Part no. Euro
ViPure fine filter set for ventilation unit Set for 1 filter change ■ 1 supply air filter F7 / ISO ePM1 50 % ■ 1 extract air filter G4 / ISO Coarse 60 %								

5.2

5853556

5.2



5.3

Vitoair

Header

Ductwork system for routing directly from the Vitoair or Vitovent ventilation unit to the air distributor

- Insulated EPP ductwork prevents the formation of condensation without the need for additional insulation measures.
- Flexible ductwork system for installation in tight spaces
- Outdoor and exhaust air apertures for hygienic installation of exhaust and outdoor air without thermal bridging

Benefits for trade partners

- Flexible solutions for new build and modernisation projects
- Simple planning with Vitoair Planner
- Fast, secure, click & go installation thanks to integral gaskets
- Viewing window for visible fault-free connections
- Highly flexible (pliable) ducts
- Easy to cut to length thanks to printed markings
- Fully compatible round and flat ducts and system components

Benefits for users

- Flow optimised design for silent operation
- Antibacterial inner walls for the highest standards of hygiene

8/2023

5472788

VITOAIR

Air distribution systems

Services/selection aid

Ductwork selection aid

Ventilation unit	Recommended nominal diameter		
	DN 125	DN 160	DN 180
Wall mounted <ul style="list-style-type: none"> ■ Vitovent 300-W, type H32S A225 ■ Vitovent 300-W, type H32S C325 ■ Vitovent 300-W, type H32S C400 ■ Vitovent 300-W, type H32S A600 	X	X	X X
Suspended from ceiling <ul style="list-style-type: none"> ■ Vitoair FS, type 300E 		X	

5.3

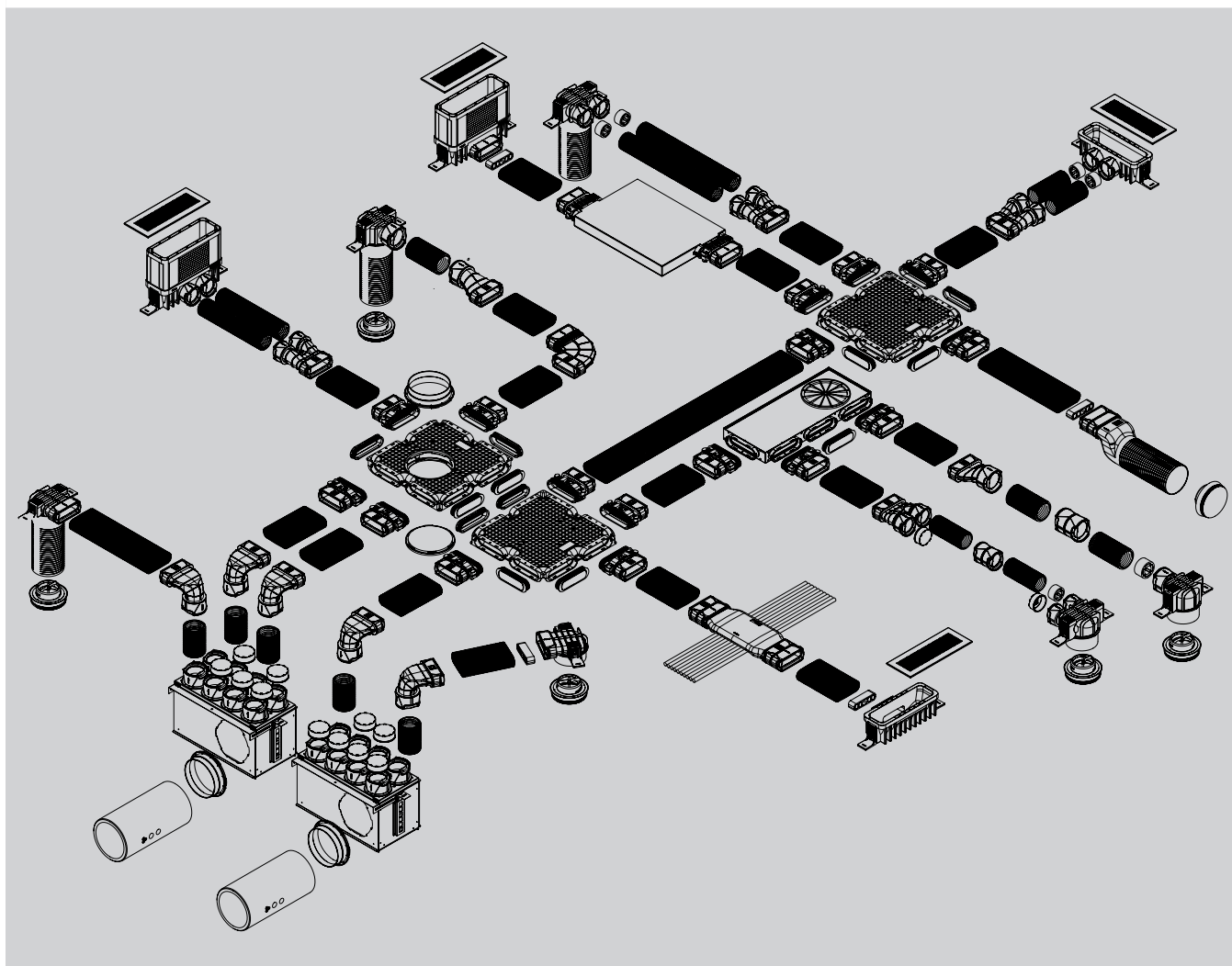





Example
Plastic air distribution system (flat/round)**5.3****Notes:**

The illustration shows a general example. This does not replace the need for on-site engineering.

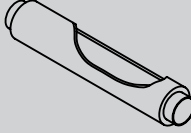
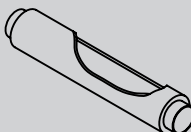
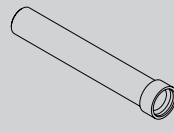
VITOAIR

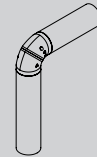
Air distribution systems

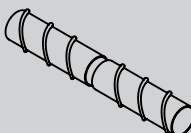
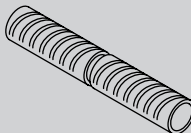
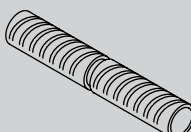
5.3

Header							
Ductwork (DN)				125	160	180	MG WV
Silencer <ul style="list-style-type: none"> Made from flexible pipe Packing thickness 25 mm Length 1 m 				-	9521461 141,-	7373027 177,-	Part no. Euro
Silencer <ul style="list-style-type: none"> Made from flexible pipe Packing thickness 50 mm Length 1 m 				7249105 123,-	ZK03036 141,-	ZK03037 160,-	Part no. Euro
Pipe with female connection <ul style="list-style-type: none"> Made from EPP, heat-insulating 1 m long; may be trimmed to size 				7501764 45,-	7501765 61,-	7501766 70,-	Part no. Euro
90° bend with female connection <ul style="list-style-type: none"> Made from EPP, heat-insulating Can also be split and used as a 45° bend 				7501767 36,-	7501768 45,-	7501769 57,-	Part no. Euro
90° bend, compact <ul style="list-style-type: none"> 90° bend with small radius For routing outdoor air and exhaust air via the installation wall with Vitovent 300-W 1 m EPP pipe, vertical with welded 90° bend, 0.5 m EPP pipe, horizontal, adjustable EPP female connection – pipes can be cut to length as required 				-	7202969 202,-	7202970 202,-	Part no. Euro
Connection sleeve Made from EPP, heat-insulating 				7501770 11,10	7501771 11,10	7501772 14,10	Part no. Euro
Sliding female connection <ul style="list-style-type: none"> To simplify subsequent dismantling of air distribution system Made from EPP, heat-insulating 				ZK01770 31,-	ZK01890 31,-	ZK01891 31,-	Part no. Euro
Mounting bracket For fixing the header to a wall or ceiling				7501773 14,10			Part no. Euro
Folded spiral-seam tube Length 3 m 				7249104 70,-	9521428 98,-	7373026 110,-	Part no. Euro
Flexible pipe <ul style="list-style-type: none"> Incl. thermal insulation Very flexible aluminium laminate hose Aluminium inner coating Flexible length of 1 to 6 m, can be trimmed/clinched Delivery length: 6 m 				ZK02535 120,-	ZK02536 141,-	ZK02537 155,-	Part no. Euro
Flexible pipe <ul style="list-style-type: none"> Excl. thermal insulation Plastic duct with aluminium inner coating Flexible length of 1 to 10 m, can be trimmed/clinched Delivery length: 10 m 				ZK02532 82,-	ZK02533 104,-	ZK02534 125,-	Part no. Euro
Clamp, flexible pipe (10 pce) To secure the flexible pipe to the ventilation unit and components.				ZK02644 39,-	ZK02645 39,-	ZK02646 39,-	Part no. Euro
Connection piece To join two folded spiral-seam tubes or flexible ducts. 				7249103 10,10	9521437 13,-	7373025 14,10	Part no. Euro

5472788
5472788

Header				
Ductwork (DN)	125	160	180	MG WV
Iris diaphragm For reducing the airflow rate in the case of high pressure differentials between different distribution levels	ZK01898 117,-	ZK01899 117,-	-	Part no. Euro
90 ° bend Made from zinc-plated sheet steel.	7249106 39,-	9521431 57,-	7373028 80,-	Part no. Euro
45 ° bend Made from zinc-plated sheet steel.	7249107 35,-	9521725 43,-	7373029 53,-	Part no. Euro
Tee ■ Made from zinc-plated sheet steel ■ Outlet 90° ■ DN 125/125/125	7249110 47,-	-	-	Part no. Euro
Tee ■ Made from zinc-plated sheet steel ■ Outlet 90° ■ DN 160/160/160	-	7190179 93,-	-	Part no. Euro
Tee ■ Made from zinc-plated sheet steel ■ Outlet 90° ■ DN 180/180/180	-	-	7373031 99,-	Part no. Euro
Tee ■ Made from zinc-plated sheet steel ■ Outlet 90° ■ DN 125/100/100	7299292 107,-	-	-	Part no. Euro
Tee ■ Made from zinc-plated sheet steel ■ Outlet 90° ■ DN 160/125/125	-	7299293 121,-	-	Part no. Euro
Reducer ■ Made from zinc-plated sheet steel ■ DN 125/100	7249109 47,-	-	-	Part no. Euro
Reducer ■ Made from zinc-plated sheet steel ■ DN 160/125	7249108 63,-	-	-	Part no. Euro
Reducer ■ Made from zinc-plated sheet steel ■ DN 180/160	-	7373030 66,-	-	Part no. Euro
Reducer ■ Made from zinc-plated sheet steel ■ DN 200/180	-	-	7973368 41,-	Part no. Euro
Reducer, insulated ■ Made from zinc-plated sheet steel ■ DN 200/180	-	-	7973369 49,-	Part no. Euro



5.3





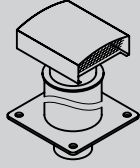
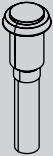
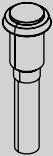

5472788

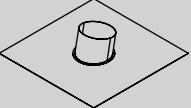
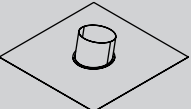
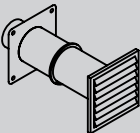
VITOAIR

Air distribution systems

5.3

Outdoor air and exhaust air apertures				
Ductwork	125	160	180	MG WV
<p>Outdoor and exhaust air outlets</p> <ul style="list-style-type: none"> ▶ Outdoor and exhaust air outlets adapted to the ventilation units (e.g., combined outdoor and exhaust air outlet in one element); see appliance price sheets. ▶ Combined external wall outlet with Vitocal 200-A; see Register 2 of price sheet for Vitocal 200-A. 				
<p>Roof outlet (pitched roof) For outdoor air and exhaust air</p> <ul style="list-style-type: none"> ■ Made from stainless steel, natural ■ Removable hood ■ With lead flashing and bird guard ■ With insulation sleeve ■ EPP pipe sleeve Ø 200 (internal) and Ø 300 mm (external) prevents thermal bridging <p><i>The Vitovent 300 with connections DN 125 requires one reducer DN 160/125 and flexible pipe.</i></p> 	-	9562054 543,-		Part no. Euro
<p>Roof outlet For outdoor air and exhaust air</p> <ul style="list-style-type: none"> ■ Colour: Black ■ With bird guard and insulation sleeve ■ Length 1 m 	7501780 189,-	7501781 218,-		Part no. Euro
<p>Roof outlet For outdoor air and exhaust air</p> <ul style="list-style-type: none"> ■ Colour: Terracotta ■ With bird guard and insulation sleeve ■ Length 1 m 	ZK01906 190,-	ZK01907 216,-		Part no. Euro
<p>Flat roof connection for roof outlet <i>For roof outlet, part no. 7501780, 7501781, ZK01906 and ZK01907.</i></p> 	7501782 43,-	7501783 43,-		Part no. Euro
<p>Universal roof tile for roof pitches 20° to 50°</p> <ul style="list-style-type: none"> ■ For Roman tiles, standard roof tiles, plain tiles, slate and other types of roof cover ■ Colour: Black <p><i>For roof outlet, part no. 7501780 and 7501781.</i></p> 	7501784 197,-	7501787 197,-		Part no. Euro
<p>Universal roof tile for roof pitches 20° to 50°</p> <ul style="list-style-type: none"> ■ For Roman tiles, standard roof tiles, plain tiles, slate and other types of roof cover ■ Colour: Terracotta <p><i>For roof outlet, part no. ZK01906 and ZK01907.</i></p> 	ZK01908 197,-	ZK01909 197,-		Part no. Euro
<p>External wall outlet With weather grille, insect guard and insulating sleeves</p> <ul style="list-style-type: none"> ■ Extremely low pressure drop with a large unobstructed cross-section ■ EPP pipe sleeve Ø 200 (internal) and Ø 300 mm (external) prevents thermal bridging ■ For wall thicknesses from 300 to 600 mm ■ Ø 160 mm with plastic grille ■ Ø 180 mm with stainless steel grille 	-	9562053 335,-	7439114 469,-	Part no. Euro

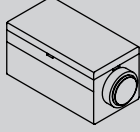



Outdoor air and exhaust air apertures					
Ductwork		125	160	180	MG WV
External wall cover For direct connection to EPP pipe <ul style="list-style-type: none"> ■ With bird guard ■ With drip edge ■ Colour: White (sheet metal) 		ZK03025 129,-	ZK03026 123,-	ZK03027 130,-	Part no. Euro
Design external wall cover For direct connection to EPP pipe <ul style="list-style-type: none"> ■ With bird guard ■ With drip edge ■ Stainless steel 		ZK05350 78,-	ZK05351 85,-	ZK05352 87,-	Part no. Euro
Outdoor and exhaust air add-on To divert the outdoor and exhaust air routing above ground level <ul style="list-style-type: none"> ■ To meet enhanced hygiene requirements to DIN 1946-6 ■ Protection from intake of leaves, snow etc. 		ZK01896 590,-	ZK01897 706,-		Part no. Euro
Bird guard for outdoor and exhaust air add-on 		ZK01893 49,-	ZK01894 49,-		Part no. Euro
Insect guard for outdoor and exhaust air add-on 		ZK01892 49,-	ZK01895 49,-		Part no. Euro
Extension for outdoor and exhaust air add-on For extending the outdoor and exhaust air add-on by 500 mm 		7528052 70,-	7528053 70,-		Part no. Euro
Outdoor air filter box with connection pieces For installation in the outdoor air duct <ul style="list-style-type: none"> ■ Thermally insulated plastic (EPP) casing ■ Pocket filter F7 ■ With connection piece suitable for the ductwork 		ZK01262 508,-	ZK01263 408,-	ZK01264 514,-	Part no. Euro
Accessories					
Ductwork		125	160	180	MG WV
Cold shrink tape 1 roll of 15 m		7143928 47,-			Part no. Euro

5.3

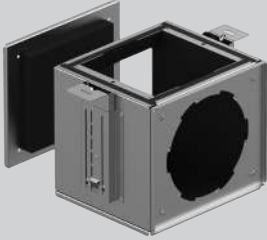

VITOAIR

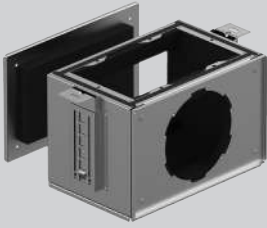
Air distribution systems

5.3

Air distribution boxes and connecting plates			
Air distribution			MG WV
Notes: <ul style="list-style-type: none"> Also order one connecting plate and one distributor connector for every main connection on the air distribution box. 			
Air distribution box compact XS <ul style="list-style-type: none"> Air distribution box made from stainless steel plate, suitable for supply air or extract air Integral sound-absorbing lining and inspection port; can be installed on wall or ceiling; incl. bracket For connecting 1 distributor connector Holds one XS connecting plate either at the front or top Dimensions: Width 266 mm x height 238 mm x depth 249 mm Permissible max. flow rate 160 m³/h 		7377369 130,-	Part no. Euro
4-way connecting plate R75 XS <ul style="list-style-type: none"> Connecting plate made from stainless steel plate for installation on air distribution box compact XS 4x connections for direct connection to round duct R75 1x sealing plug for round duct R75 Dimensions: Width 266 mm x height 227 mm x depth 74 mm 		7377370 69,-	Part no. Euro
4-way connecting plate R90 XS <ul style="list-style-type: none"> Connecting plate made from stainless steel plate for installation on air distribution box compact XS 4x connections for direct connection to round duct R90 1x sealing plug for round duct R90 Dimensions: Width 266 mm x height 227 mm x depth 83 mm 		7377371 75,-	Part no. Euro
Air distribution box compact S <ul style="list-style-type: none"> Air distribution box made from stainless steel plate, suitable for supply air or extract air Integral sound-absorbing lining and inspection port; can be installed on wall or ceiling; incl. bracket For connecting 1 distributor connector Holds one S connecting plate either at the front or top Dimensions: Width 360 mm x height 238 mm x depth 249 mm Permissible max. flow rate 240 m³/h 		7377372 156,-	Part no. Euro
6-way connecting plate R75 S <ul style="list-style-type: none"> Connecting plate made from stainless steel plate for installation on air distribution box compact S 6x connections for direct connection to round duct R75 1x sealing plug for round duct R75 Dimensions: Width 360 mm x height 227 mm x depth 74 mm 		7377373 89,-	Part no. Euro

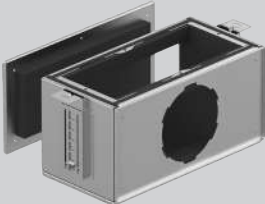
5472788
5472789

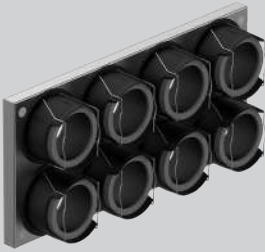
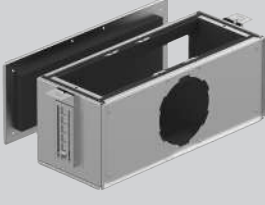
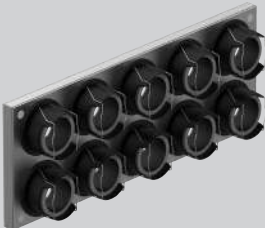



Air distribution boxes and connecting plates			
Air distribution			MG WV
<p>6-way connecting plate R90 S</p> <ul style="list-style-type: none"> ■ Connecting plate made from stainless steel plate for installation on air distribution box compact S ■ 6x connections for direct connection to round duct R90 ■ 1x sealing plug for round duct R90 ■ Dimensions: Width 360 mm x height 227 mm x depth 83 mm 		7377374 92,-	Part no. Euro
<p>Air distribution box compact M</p> <ul style="list-style-type: none"> ■ Air distribution box made from stainless steel plate, suitable for supply air or extract air ■ Integral sound-absorbing lining and inspection port; can be installed on wall or ceiling; incl. bracket ■ For connecting 1 distributor connector ■ Holds one M connecting plate either at the front or top ■ Dimensions: Width 470 mm x height 238 mm x depth 249 mm ■ Permissible max. flow rate 320 m³/h 		7377375 180,-	Part no. Euro
<p>8-way connecting plate R75 M</p> <ul style="list-style-type: none"> ■ Connecting plate made from stainless steel plate for installation on air distribution box compact M ■ 8x connections for direct connection to round duct R75 ■ 1x sealing plug for round duct R75 ■ Dimensions: Width 470 mm x height 227 mm x depth 74 mm 		7377376 112,-	Part no. Euro
<p>8-way connecting plate R90 M</p> <ul style="list-style-type: none"> ■ Connecting plate made from stainless steel plate for installation on air distribution box compact M ■ 8x connections for direct connection to round duct R90 ■ 1x sealing plug for round duct R90 ■ Dimensions: Width 470 mm x height 227 mm x depth 83 mm 		7377377 119,-	Part no. Euro
<p>Air distribution box compact L</p> <ul style="list-style-type: none"> ■ Air distribution box made from stainless steel plate, suitable for supply air or extract air ■ Integral sound-absorbing lining and inspection port; can be installed on wall or ceiling; incl. bracket ■ For connecting 1 distributor connector ■ Holds one L connecting plate either at the front or top ■ Dimensions: Width 582 mm x height 238 mm x depth 249 mm ■ Permissible max. flow rate 400 m³/h 		7377378 207,-	Part no. Euro
<p>10-way connecting plate R75 L</p> <ul style="list-style-type: none"> ■ Connecting plate made from stainless steel plate for installation on air distribution box compact L ■ 10x connections for direct connection to round duct R75 ■ 1x sealing plug for round duct R75 ■ Dimensions: Width 582 mm x height 227 mm x depth 74 mm 		7377379 147,-	Part no. Euro

5.3

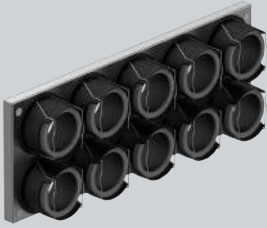
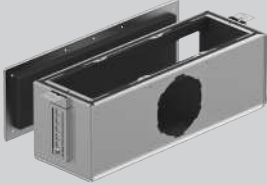

VITOAIR

Air distribution systems

5.3

Air distribution boxes and connecting plates			
Air distribution			MG WV
<p>10-way connecting plate R90 L</p> <ul style="list-style-type: none"> ■ Connecting plate made from stainless steel plate for installation on air distribution box compact L ■ 10x connections for direct connection to round duct R90 ■ 1x sealing plug for round duct R90 ■ Dimensions: Width 582 mm x height 227 mm x depth 83 mm 		7377380 156,-	Part no. Euro
<p>Air distribution box compact XL</p> <ul style="list-style-type: none"> ■ Air distribution box made from stainless steel plate, suitable for supply air or extract air ■ Integral sound-absorbing lining and inspection port; can be installed on wall or ceiling; incl. bracket ■ For connecting 1 distributor connector ■ Holds one XL connecting plate either at the front or top ■ Dimensions: Width 695 mm x height 238 mm x depth 249 mm ■ Permissible max. flow rate 460 m³/h 		7377381 231,-	Part no. Euro
<p>12-way connecting plate R75 XL</p> <ul style="list-style-type: none"> ■ Connecting plate made from stainless steel plate for installation on air distribution box compact XL ■ 12x connections for direct connection to round duct R75 ■ 1x sealing plug for round duct R75 ■ Dimensions: Width 695 mm x height 227 mm x depth 74 mm 		7377382 167,-	Part no. Euro
<p>12-way connecting plate R90 XL</p> <ul style="list-style-type: none"> ■ Connecting plate made from stainless steel plate for installation on air distribution box compact XL ■ 12x connections for direct connection to round duct R90 ■ 1x sealing plug for round duct R90 ■ Dimensions: Width 695 mm x height 227 mm x depth 83 mm 		7377383 176,-	Part no. Euro
<p>Air distribution box DN 125 F50</p> <ul style="list-style-type: none"> ■ Compact supply and extract air distributor in a single component ■ Integral sound insulation ■ Connection and dimensions designed for Vitovent 200-C and Vitovent 300-C ■ For direct connection to the air distribution system via connecting pieces ■ 4 supply air and 4 extract air connections for flat duct F50 ■ 4 sealing plug ■ Dimensions: 660 x 500 x 200 mm 		7377016 739,-	Part no. Euro
<p>Air distribution box DN 125 R75</p> <ul style="list-style-type: none"> ■ Compact supply and extract air distributor in a single component ■ Integral sound insulation ■ Connection and dimensions designed for Vitovent 200-C and Vitovent 300-C ■ For direct connection to the air distribution system via connecting pieces ■ 8 supply air and 8 extract air connections for round duct R75 ■ 6 sealing plug ■ Dimensions: 660 x 500 x 200 mm 		7377017 739,-	Part no. Euro

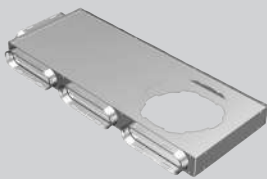
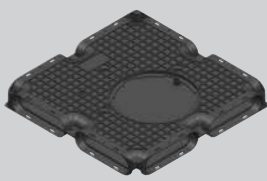
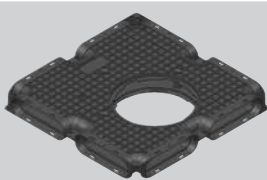
5472788
5472789

Air distribution boxes and connecting plates			
Air distribution			MG WV
<p>4-way air distributor, intermediate level</p> <ul style="list-style-type: none"> ■ Modular distributor ■ Recommended max. air flow rate 120 m³/h ■ Installation at the distribution level ■ Open top and bottom ■ 4 connections for air distribution (via connection pieces) ■ For connecting 2 distributor connections ■ 2 sealing plug <p>Dimensions: 600 x 240 x 47 mm <i>Order connection pieces separately for each connection to profiles.</i></p>		ZK06242 141,-	Part no. Euro
<p>8-way air distributor, final level</p> <ul style="list-style-type: none"> ■ Modular distributor ■ Recommended max. air flow rate 150 m³/h ■ Installation at the final level ■ Closed on one side ■ 8 connections for air distribution (via connection pieces) ■ For connecting 1 distributor connector ■ 4 sealing plug ■ May be extended by means of internal connectors <p>Dimensions: 420 x 420 x 52 mm <i>Order connection pieces separately for each connection to profiles.</i></p>		ZK06243 169,-	Part no. Euro
<p>8-way air distributor, intermediate level</p> <ul style="list-style-type: none"> ■ Modular distributor ■ Recommended max. air flow rate 150 m³/h ■ Installation at the intermediate level ■ Open top and bottom ■ For connecting 2 distributor connections ■ 8 connections for air distribution (via connection pieces) ■ 4 sealing plug ■ May be extended by means of internal connectors <p>Dimensions: 420 x 420 x 52 mm <i>Order connection pieces separately for each connection to profiles.</i></p>		ZK06244 159,-	Part no. Euro
Connection pieces			MG WV
<p>Connection piece F50</p> <p>For connection to 4-way and 8-way air distributors</p> <ul style="list-style-type: none"> ■ Integral gasket and fixing bracket 		7372830 16,-	Part no. Euro
<p>Connection piece, round duct ⁽¹⁹⁾</p> <ul style="list-style-type: none"> ■ For connecting max. 2 round ducts, external diameter 75 mm ■ Includes gaskets and locating pins ■ 1 cover 		ZK01874 12,-	Part no. Euro
<p>Internal connector</p> <ul style="list-style-type: none"> ■ For connecting 8-way air distributors 		ZK01871 30,-	Part no. Euro
<p>Distributor connection cover, flat</p> <ul style="list-style-type: none"> ■ For sealing unused connections on 4 and 8-way distributors 		ZK01870 14,-	Part no. Euro

5.3

VITOAIR

Air distribution systems

Air distribution boxes and connecting plates

Distributor connections

Distributor connector

- DN 125
- For connecting the header

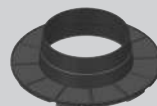

ZK01866
25,-

MG WV

Part no.
Euro

Distributor connector

- DN 160
- For connecting the header



ZK01867
25,-

Part no.
Euro

Distributor connector

- DN 180
- For connecting the header



ZK01868
27,-

Part no.
Euro

Distributor connection cover, round

- For sealing unused distributor connectors



ZK01869
21,-

Part no.
Euro

5.3

Components of the flat duct system			
Duct systems			MG WV
<p>Vitoair F50 flat duct</p> <ul style="list-style-type: none"> Flexible, walk-on flat duct made from plastic (PE) Certified antibacterial effectiveness. Smooth inside, corrugated outside. Certified microbial verification to ISO 846 Printed cut markings every metre <p>Dimensions: 140 x 50 mm</p>			
<p>Vitoair F50 flat duct</p> <ul style="list-style-type: none"> Packing unit: 50 m 		Z023106 655,-	Part no. Euro
<p>Vitoair F50 flat duct</p> <ul style="list-style-type: none"> Packing unit: 25 m 		Z023105 313,-	Part no. Euro
<p>Vitoair F50 flat duct</p> <ul style="list-style-type: none"> Packing unit: 2 m 		7372922 38,-	Part no. Euro
<p>F50 connector</p> <ul style="list-style-type: none"> For connecting flat ducts F50 Integral gasket and fixing bracket 		7372824 19,10	Part no. Euro
<p>90° bend, narrow side F50</p> <ul style="list-style-type: none"> For compact diversion of flat duct F50 at the distribution level Integral gasket and fixing bracket 		7372833 40,-	Part no. Euro
<p>90° bend, wide side F50</p> <ul style="list-style-type: none"> For compact diversion of flat duct F50 at the distribution level Integral gasket and fixing bracket 		7372834 33,-	Part no. Euro
<p>Adaptor, F50 to F90</p> <ul style="list-style-type: none"> Straight adaptor from flat duct F50 to round duct R90 Integral gasket and fixing bracket 		7372827 19,10	Part no. Euro
<p>90° bend, F50 to R90</p> <ul style="list-style-type: none"> 90° bend for connecting flat duct F50 to round duct R90 Integral gasket and fixing bracket 		7372828 21,-	Part no. Euro
<p>Adaptor, F50 to 2x R75</p> <ul style="list-style-type: none"> For connecting flat duct F50 to 2 round ducts R75 Integral gasket and fixing bracket 1 sealing plug 		7372829 24,-	Part no. Euro
<p>Cable bridge F50</p> <ul style="list-style-type: none"> For bridging cables with a diameter of up to 22 mm. Can also be used for crossing F50 flat ducts. 		7377282 40,-	Part no. Euro
<p>Air diffuser casing F50 S</p> <ul style="list-style-type: none"> Air diffuser made of PP for connection of a Vitoair F50 flat duct, universal application for supply air or extract air, incl. mounting bracket Installation in wall, floor or ceiling Secured by means of adjustable mounting brackets Connector length 48 mm 		7377338 37,-	Part no. Euro





5.3

5472788

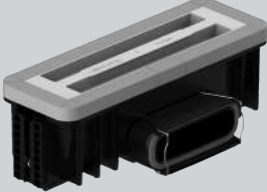

VITOAIR

Air distribution systems

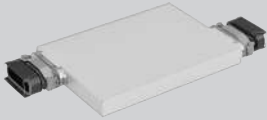
5.3

Components of the flat duct system			
Duct systems			MG WV
<p>Air diffuser casing F50 L</p> <ul style="list-style-type: none"> ■ Air diffuser made of PP for connection of a Vitoair F50 flat duct, universal application for supply air or extract air, incl. mounting bracket ■ Installation in wall, floor or ceiling ■ Secured by means of adjustable mounting brackets ■ Connector length 300 mm 		7377339 37,-	
<p>Air diffuser casing, straight F50</p> <ul style="list-style-type: none"> ■ Air diffuser, straight, made of HDPE, for connection of a Vitoair F50 flat duct, universal application for supply air or extract air ■ Installation in wall or ceiling ■ Connector length 300 mm 		7377344 43,-	Part no. Euro
<p>Air diffuser casing F50 S, rectangular</p> <ul style="list-style-type: none"> ■ Air diffuser, rectangular, made of PP, for connection of a Vitoair F50 flat duct, universal application for supply air or extract air, incl. mounting bracket ■ Installation in wall, floor or ceiling ■ Secured by means of adjustable mounting brackets ■ Overall height 100 mm (can be extended to 150 mm with the mounting brackets) 		7377347 48,-	Part no. Euro
<p>Air diffuser casing F50 L, rectangular</p> <ul style="list-style-type: none"> ■ Air diffuser, rectangular, made of PP, for connection of a Vitoair F50 flat duct, universal application for supply air or extract air, incl. mounting bracket ■ Installation in wall, floor or ceiling ■ Secured by means of adjustable mounting brackets ■ Overall height 250 mm (can be extended to 300 mm with the mounting brackets) 		7377354 50,-	Part no. Euro
<p>Flat silencer, flat duct 50</p> <ul style="list-style-type: none"> ■ Installed height 56 mm ■ Can be used as in-line or duct silencer ■ 2 connections, flat duct 50 		ZK06245 196,-	Part no. Euro

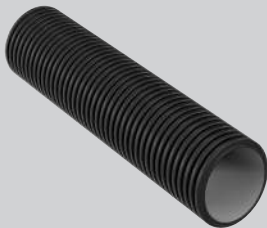
5472788
5170788

Components of the round duct system			
Duct systems			MG WV
Vitoair round duct <ul style="list-style-type: none"> Flexible, walk-on round duct made from plastic (PE) Certified antibacterial effectiveness. Smooth inside, corrugated outside. Printed cut markings every metre 			
Vitoair round duct R75 <ul style="list-style-type: none"> Packing unit: 50 m Ø 75 mm 		Z023108 194,-	Part no. Euro
Vitoair round duct R75 <ul style="list-style-type: none"> Packing unit: 25 m Ø 75 mm 		Z023107 104,-	Part no. Euro
Vitoair round duct R90 <ul style="list-style-type: none"> Packing unit: 50 m Ø 90 mm 		Z023111 263,-	Part no. Euro
Vitoair round duct R90 <ul style="list-style-type: none"> Packing unit: 25 m Ø 90 mm 		Z023110 127,-	Part no. Euro
Vitoair round duct R90 <ul style="list-style-type: none"> Packing unit: 2 m Ø 90 mm 		7372921 16,60	Part no. Euro
R75 connector <ul style="list-style-type: none"> For connecting 2 round ducts R75 Integral gasket and fixing bracket 			7372825 14,-
R90 connector <ul style="list-style-type: none"> For connecting 2 round ducts R90 Integral gasket and fixing bracket 			7372826 15,90
90° bend R75 <ul style="list-style-type: none"> For tight diversions in the distribution network Integral gasket and fixing bracket Can be trimmed; direct installation onto the profile or connecting plate 			7372923 27,-
90° bend R90 <ul style="list-style-type: none"> For tight diversions in the distribution network Integral gasket and fixing bracket Can be trimmed; direct installation onto the profile or connecting plate 			7372924 27,-
Adaptor, F50 to F90 <ul style="list-style-type: none"> Straight adaptor from flat duct F50 to round duct R90 Integral gasket and fixing bracket 			7372827 19,10

5.3

5472788



VITOAIR

Air distribution systems

5.3

Components of the round duct system			
Duct systems			MG WV
90° bend, F50 to R90 <ul style="list-style-type: none"> ■ 90° bend for connecting flat duct F50 to round duct R90 ■ Integral gasket and fixing bracket 		7372828 21,-	Part no. Euro
Adaptor, F50 to 2x R75 <ul style="list-style-type: none"> ■ For connecting flat duct F50 to 2 round ducts R75 ■ Integral gasket and fixing bracket ■ 1 sealing plug 		7372829 24,-	Part no. Euro
Air diffuser casing R75 S <ul style="list-style-type: none"> ■ Air diffuser made of PP for connection of a Vitoair R75 round duct, universal application for supply air or extract air, incl. mounting bracket ■ Installation in wall, floor or ceiling ■ Secured by means of adjustable mounting brackets ■ 1x sealing plug for round duct R75 ■ Connector length 64 mm 		7377340 40,-	Part no. Euro
Air diffuser casing R75 L <ul style="list-style-type: none"> ■ Air diffuser made of PP for connection of a Vitoair R75 round duct, universal application for supply air or extract air, incl. mounting bracket ■ Installation in wall, floor or ceiling ■ Secured by means of adjustable mounting brackets ■ 1x sealing plug for round duct R75 ■ Connector length 300 mm 		7377341 40,-	Part no. Euro
Air diffuser casing, straight R75 <ul style="list-style-type: none"> ■ Air diffuser, straight, made of HDPE, for connection of a Vitoair R75 round duct, universal application for supply air or extract air ■ Installation in wall or ceiling ■ 1x sealing plug for round duct R75 ■ Connector length 300 mm 		7377351 48,-	Part no. Euro
Air diffuser casing R75 S, rectangular <ul style="list-style-type: none"> ■ Air diffuser, rectangular, made of PP, for connection of a Vitoair R75 round duct, universal application for supply air or extract air, incl. mounting bracket ■ Installation in wall, floor or ceiling ■ Secured by means of adjustable mounting brackets ■ 1x sealing plug for round duct R75 ■ Overall height 130 mm (can be extended to 180 mm with the mounting brackets) 		7377350 50,-	Part no. Euro
Mounting attachment, rectangular, 230 mm <ul style="list-style-type: none"> ■ Mounting attachment for unfinished concrete for air diffuser casing, rectangular ■ Extension of up to 230 mm ■ Can be trimmed to individual requirements 		7973069 53,-	Part no. Euro

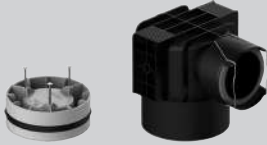
5472788
5472788









Components of the round duct system			
Duct systems			MG WV
<p>Air diffuser casing R75 L, rectangular</p> <ul style="list-style-type: none"> ■ Air diffuser, rectangular, made of PP, for connection of a Vitoair R75 round duct, universal application for supply air or extract air, incl. mounting bracket ■ Installation in wall, floor or ceiling ■ Secured by means of adjustable mounting brackets ■ 1x sealing plug for round duct R75 ■ Overall height 280 mm (can be extended to 330 mm with the mounting brackets) 		7377353 53,-	Part no. Euro
<p>Air diffuser casing R90 S</p> <ul style="list-style-type: none"> ■ Air diffuser made of PP for connection of a Vitoair R90 round duct, universal application for supply air or extract air, incl. mounting bracket ■ Installation in wall, floor or ceiling ■ Secured by means of adjustable mounting brackets ■ Connector length 64 mm 		7377342 40,-	Part no. Euro
<p>Air diffuser casing set R90 S</p> <ul style="list-style-type: none"> ■ Air diffuser made of PP for connection of a Vitoair R90 round duct, universal application for supply air or extract air, incl. fixings ■ Installation in cast-in-situ concrete formwork ceilings ■ Secured by attachment to shuttering board using 3 steel nails ■ Connector length 64 mm 		7973059 42,-	Part no. Euro
<p>Air diffuser casing R90 L</p> <ul style="list-style-type: none"> ■ Air diffuser made of PP for connection of a Vitoair R90 round duct, universal application for supply air or extract air, incl. mounting bracket ■ Installation in wall, floor or ceiling ■ Secured by means of adjustable mounting brackets ■ Connector length 300 mm 		7377343 40,-	Part no. Euro
<p>Air diffuser casing, straight R90</p> <ul style="list-style-type: none"> ■ Air diffuser, straight, made of HDPE, for connection of a Vitoair R90 round duct, universal application for supply air or extract air ■ Installation in wall or ceiling ■ Connector length 300 mm 		7377348 48,-	Part no. Euro

5.3







VITOAIR

Air distribution systems

5.3

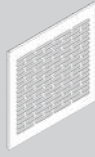
Vents and cover grilles			
Vents and cover grilles			MG WV
"Comfort design" air diffuser			
Wall/ceiling air diffuser (design) <ul style="list-style-type: none"> ■ Retainer for design cover (order cover separately) ■ Restrictor can be pre-adjusted in line with the intended air flow rate ■ Max. air flow rate 60 m³/h ■ For diverter closed on one side and for straight through diverter ■ Mounting ring 		ZK03038 47,- Part no. Euro	
Supply and extract air design cover <ul style="list-style-type: none"> ■ For wall/ceiling air diffusers (design) ■ Supply and extract air ■ Round, white ■ Sound-absorbing effect 		ZK03039 19,- Part no. Euro	
Supply and extract air design cover <ul style="list-style-type: none"> ■ For wall/ceiling air diffusers (design) ■ Supply and extract air ■ Square, white ■ Sound-absorbing effect 		ZK03040 19,- Part no. Euro	
Supply and extract air design cover <ul style="list-style-type: none"> ■ For wall/ceiling air diffusers (design) ■ Supply and extract air ■ Rounded, white ■ Sound-absorbing effect 		ZK03041 19,- Part no. Euro	
Supply and extract air design cover <ul style="list-style-type: none"> ■ For wall/ceiling air diffusers (design) ■ Supply and extract air ■ Elliptical, white ■ Sound-absorbing effect 		ZK03042 19,- Part no. Euro	
Supply and extract air design cover <ul style="list-style-type: none"> ■ For wall/ceiling air diffusers (design) ■ Supply and extract air ■ Rectangular, white ■ Sound-absorbing effect 		ZK03043 19,- Part no. Euro	
Supply and extract air design cover <ul style="list-style-type: none"> ■ For wall/ceiling air diffusers (design) ■ Supply and extract air ■ Round, stainless steel look ■ Sound-absorbing effect 		ZK03044 28,- Part no. Euro	
Supply and extract air design cover <ul style="list-style-type: none"> ■ For wall/ceiling air diffusers (design) ■ Supply and extract air ■ Square, stainless steel look ■ Sound-absorbing effect 		ZK03045 28,- Part no. Euro	
Air deflector insert For adjusting the flow direction from the vent.		ZK03046 7,- Part no. Euro	

5472788
5472788





Vents and cover grilles			
Vents and cover grilles			MG WV
"Flat design" air diffuser			
Wall/ceiling air diffuser <ul style="list-style-type: none"> ■ Restrictor and cover retainer (order cover separately) ■ Restrictor can be pre-adjusted in line with the intended air flow rate ■ Including supply air and extract air filter G3 ■ Max. air flow rate 60 m³/h ■ For diverter closed on one side and for straight through diverter 		ZK01855 17,- Part no. Euro	
Supply and extract air cover <ul style="list-style-type: none"> ■ For wall/ceiling air diffuser ■ Supply and extract air ■ Stainless steel look 		ZK01856 25,- Part no. Euro	
Supply and extract air cover <ul style="list-style-type: none"> ■ For wall/ceiling air diffuser ■ Supply and extract air ■ Plastic ■ White 		ZK01857 25,- Part no. Euro	
Swirl diffuser cover <ul style="list-style-type: none"> ■ For wall/ceiling air diffuser ■ Supply air ■ Stainless steel look 		ZK01858 57,- Part no. Euro	
Swirl diffuser cover <ul style="list-style-type: none"> ■ For wall/ceiling air diffuser ■ Supply air ■ White 		ZK01859 57,- Part no. Euro	
Wide-angle diffuser cover <ul style="list-style-type: none"> ■ For wall/ceiling air diffuser ■ Supply air ■ Stainless steel look 		ZK01860 57,- Part no. Euro	
Wide-angle diffuser cover <ul style="list-style-type: none"> ■ For wall/ceiling air diffuser ■ Supply air ■ White 		ZK01861 57,- Part no. Euro	

5.3





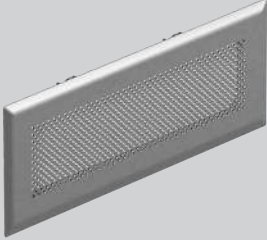
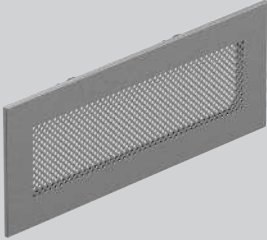
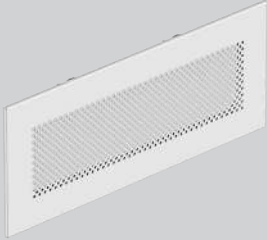

VITOAIR

Air distribution systems

5.3

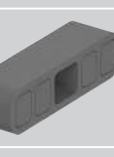
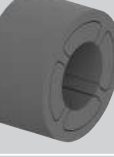
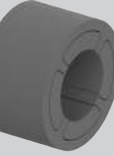
Vents and cover grilles			
Vents and cover grilles			MG WV
"Basic" vents			
Supply and extract air vent <ul style="list-style-type: none"> White Max. air flow rate 60 m³/h For diverter closed on one side and for straight through diverter Sound-absorbing effect With gasket 		ZK04570 27,- Part no. Euro	
Extract air vent <ul style="list-style-type: none"> White Max. air flow rate 60 m³/h For diverter closed on one side and for straight through diverter Sound-absorbing effect With gasket 		ZK04571 24,- Part no. Euro	
Floor grille, rectangular, hole E <ul style="list-style-type: none"> Walk-on floor grille to fit rectangular air diffuser Suitable for supply air Stainless steel look Includes fixtures for securing to rectangular air diffuser casing Dimensions: 350 x 135 mm 		7377397 53,- Part no. Euro	
Wall grille, rectangular, hole E <ul style="list-style-type: none"> Wall grille suitable for supply or extract air Stainless steel look Includes fixtures for securing to rectangular air diffuser casing Dimensions: 350 x 135 mm 		7377398 49,- Part no. Euro	
Wall grille, rectangular, hole W <ul style="list-style-type: none"> Wall grille suitable for supply or extract air White, RAL 9003 Includes fixtures for securing to rectangular air diffuser casing Dimensions: 350 x 135 mm 		7377399 49,- Part no. Euro	
Kitchen extract air vent With removable grease filter made from woven aluminium. <ul style="list-style-type: none"> Made of metal, painted white Integral restrictor element Flow rate up to 75 m³/h DN 125 		7440231 209,- Part no. Euro	

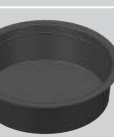
5472788
5472788

Connection pieces for flat and round ducts			
Distribution system accessories			MG WV
Gasket for connection piece <ul style="list-style-type: none"> ■ As a replacement for a damaged or lost gasket ■ On profile side 		ZK01901 8,-	Part no. Euro
Retainer, air distribution box <ul style="list-style-type: none"> ■ As a replacement for a damaged or lost air distribution box retainer ■ Suitable for wall or ceiling installation. ■ 2 pce 		7377464 36,-	Part no. Euro
Extension DN 125 <ul style="list-style-type: none"> ■ Extension of up to 100 mm for air diffuser casing and straight air diffuser casing 		7522373 34,-	Part no. Euro
Restrictor element F50 To trim the pressure drop in the ductwork <ul style="list-style-type: none"> ■ Material: EVA ■ 10 pce 		7377364 33,-	Part no. Euro
Restrictor element R75 To trim the pressure drop in the ductwork <ul style="list-style-type: none"> ■ Material: EVA ■ 10 pce 		7377367 33,-	Part no. Euro
Restrictor element R90 To trim the pressure drop in the ductwork <ul style="list-style-type: none"> ■ Material: EVA ■ 10 pce 		7377368 33,-	Part no. Euro
Pipe cutters For burr-free and safe cutting of ventilation ducts <ul style="list-style-type: none"> ■ Low effort thanks to special cutting geometry and optimal transmission ratio ■ Ergonomic handle design ■ Handle: Plastic ■ Blade: Special tool steel 		7372852 56,-	Part no. Euro
Replacement blades for pipe cutters 2 pce		7377424 55,-	Part no. Euro
Protective plug, round duct <ul style="list-style-type: none"> ■ For sealing open duct ends during construction ■ External diameter 75 mm 		ZK01877 3,-	Part no. Euro
Protective plug, round duct <ul style="list-style-type: none"> ■ For sealing open duct ends during construction ■ External diameter 90 mm 		ZK03116 16,-	Part no. Euro





5.3

5472788



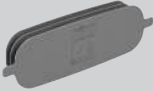
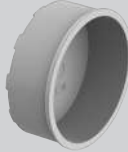

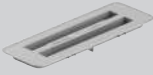
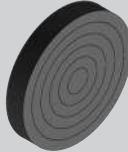
VITOAIR

Air distribution systems

5.3

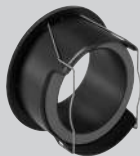
Connection pieces for flat and round ducts			
Distribution system accessories			MG WV
Sealing plug F50 ■ For sealing open duct ends during construction		7372926 3,20	Part no. Euro
Sealing plug R75 ■ For sealing unused round duct connections on the profile (dummy plug)		7372843 2,50	Part no. Euro
Sealing plug R90 ■ For sealing unused round duct connections on the profile (dummy plug)		7372844 12,50	Part no. Euro
Cover DN 125 ■ For closing off the air diffuser casing during construction		7973060 2,90	Part no. Euro
Cover, rectangular ■ For closing off the rectangular air diffuser casing during construction		7377360 6,50	Part no. Euro
Retaining clip for floor and wall grille ■ Retaining clip to replace lost retaining clips ■ 4 pce		7377867 9,60	Part no. Euro
Round restrictor element ■ Restrictor element for reducing the air flow rate in the air diffuser casing ■ Recommended to prevent flow noise in the case of substantial pressure differentials within the ductwork		ZK01816 8,-	Part no. Euro
Cable ties ■ For securing the plastic duct prior to casting in concrete ■ 100 pce		ZK01903 29,-	Part no. Euro MG N
Trimming aids ■ Set of trimming aids to protect wall, floor and ceiling surfaces when trimming air diffusers		7973067 61,-	Part no. Euro
Connector R75 ■ As replacement for damaged or lost connectors ■ For connecting round duct R75 to connecting plate of distribution box		7372835 20,-	Part no. Euro

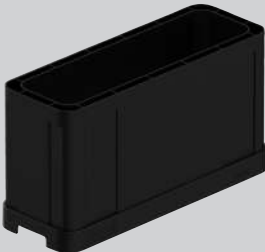
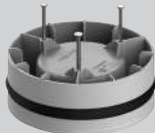

5472788
5472788

Connection pieces for flat and round ducts			
Distribution system accessories			MG WV
<p>Connector R90</p> <ul style="list-style-type: none"> ■ As replacement for damaged or lost connectors ■ For connecting round duct R90 to connecting plate of distribution box 		7372836 20,-	Part no. Euro
<p>Connector F50</p> <ul style="list-style-type: none"> ■ As replacement for damaged or lost connectors ■ For connecting F50 flat duct to DN 125 F50 air distribution box 		7372837 20,-	Part no. Euro
<p>Extension, rectangular, 150 mm</p> <ul style="list-style-type: none"> ■ Extension of up to 150 mm for rectangular air diffuser casing ■ Can be trimmed to individual requirements 		7377361 28,-	Part no. Euro
<p>Fixing for air diffuser casing S</p> <ul style="list-style-type: none"> ■ Installation on cast-in-situ concrete formwork ceilings ■ Attachment to shuttering board using 3 steel nails 		7377356 12,10	Part no. Euro
<p>Mounting bracket, short</p> <ul style="list-style-type: none"> ■ Mounting bracket made of plastic for securing the F50 air diffuser casing ■ As a replacement for a damaged or lost mounting bracket ■ Height can be adjusted by a further 22 mm as required ■ 2 pce, including 2x M8 cheese head screws 		7377868 8,60	Part no. Euro
<p>Mounting bracket, long</p> <ul style="list-style-type: none"> ■ Mounting bracket made of plastic for securing the R75 & R90 air diffuser casings and F50 & R75 rectangular air diffuser casings ■ As a replacement for a damaged or lost mounting bracket ■ Height can be adjusted by a further 50 mm as required ■ 2 pce, including 2x M8 cheese head screws 		7973077 11,40	Part no. Euro

5.3

VITOAIR

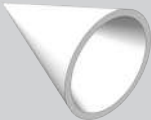
Air distribution systems

Accessories			
Filter for extract air vents			MG WV
Extract air filter (G4) <ul style="list-style-type: none"> For extract air vent DN 125 (part no. ZK04570 and ZK04571) and wall/ceiling air diffuser (design, part no. ZK03038) 5 pce 		ZK01881 38,-	Part no. Euro
Filter for wall/ceiling air diffuser <ul style="list-style-type: none"> For air diffuser (part no. ZK01855) 5 pce 		ZK01882 38,-	Part no. Euro
Filter for kitchen extract air vent For kitchen extract air vent part no. 7440231		ZK02531 55,-	Part no. Euro
Extract air filter, rectangular <ul style="list-style-type: none"> Extract air filter for rectangular air diffuser ISO Coarse ≥ 45 % (G4) 5 pce 		7973065 22,-	Part no. Euro

5.3

VITOVENT 050-D

Decentralised ventilation unit with heat recovery
for single rooms or apartments

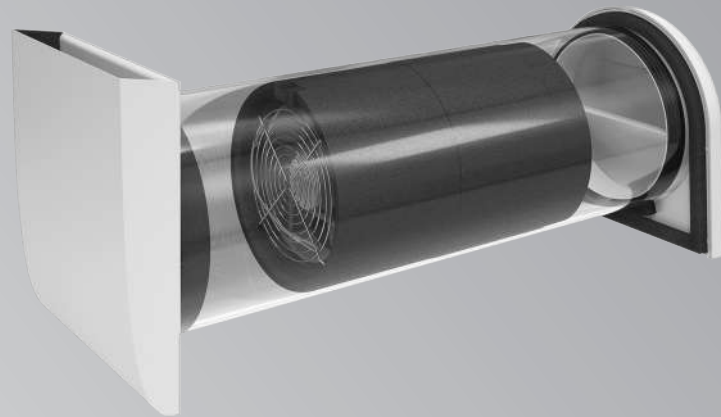

5.4

Vitovent 050-D

Type H20E A43



- Air flow rate up to 43 m³/h
- 2 to 6 fans and one programming unit form one fan group.
- Operation with change of direction
- Simultaneous heat recovery and humidity control via integrated, cleanable ceramic thermal stores
- Tool-free maintenance from the living space
- Easy installation with standard Ø 162 mm core-drilled hole
- Energy cost savings through heat recovery
- Reliable moisture protection without having to frequently open windows.
- Easy operation with rotary controller or large buttons
- Airing mode for cooling during summer nights
- Installation in two steps with sets for unfinished walls and completion
- Star wiring configuration
- Anti-twist connections

4/2023

5472998

VITOVENT 050-D

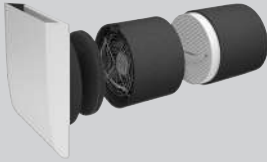







Ventilation units with heat recovery
for single rooms or apartments

Ventilation units (decentralised)		
Ventilation units		
Type	H20E A43	MG WV
Vitovent 050-D, type H20E A43 <ul style="list-style-type: none"> ■ 1 fan unit for wall mounting ■ Fan ■ Thermal store ■ Internal wall cover (white) ■ Filter (coarse filter) <i>A wall sleeve and external wall cover must also be ordered.</i>		Z015395 464,- <A> - <A> -
		Part no. Euro 
Specification		
Air flow rate <ul style="list-style-type: none"> ■ Stage 1 ■ Stage 2 ■ Stage 3 ■ Stage 4 	16 22 30 43	m³/h m³/h m³/h m³/h
Heat recovery level (Heat recovery and humidity control)	Up to 90	%
IP rating	IP 42	
Minimum diameter of core-drilled hole	162	mm
Dimensions of internal wall cover <ul style="list-style-type: none"> ■ Width ■ Height ■ Depth 	190 214 40	mm mm mm

5.4

VITOVENT 050-D

Accessories

Ventilation units (decentralised)			
Covers & wall sleeves			MG WV
External wall cover <ul style="list-style-type: none"> External wall cover (white), reduces draughts 		ZK03627 224,-	Part no. Euro
Design stainless steel external wall cover <ul style="list-style-type: none"> External wall cover (stainless steel), reduces draughts 		ZK03629 311,-	Part no. Euro
Stainless steel external wall cover <ul style="list-style-type: none"> External wall cover (stainless steel), reduces draughts 		ZK04639 296,-	Part no. Euro
Installation element for window reveal, white <ul style="list-style-type: none"> Unobtrusive appearance and high sound insulation against outside noise External grille, reduces draughts 		7973310 337,-	Part no. Euro
Installation element for window reveal, anthracite <ul style="list-style-type: none"> Unobtrusive appearance and high sound insulation against outside noise External grille, reduces draughts 		7973309 337,-	Part no. Euro
Round wall sleeve <ul style="list-style-type: none"> 500 mm long (can be trimmed to size) Ø 160 mm Protective plugs 		ZK02707 77,-	Part no. Euro
Round wall sleeve <ul style="list-style-type: none"> 700 mm long (can be trimmed to size) Ø 160 mm Protective plugs 		ZK02708 93,-	Part no. Euro
Square installation set <ul style="list-style-type: none"> Installation block to enclose the round wall sleeve with external wall cover 3 % fall for secure installation Material: Neopor 		ZK02713 86,-	Part no. Euro

5.4

Please note:







For installation of the Vitovent, a wall sleeve **and** an external wall cover or the installation element for the window reveal must also be ordered.

5472998

VITOVENT 050-D





Accessories

5.4

Ventilation units (decentralised)			
Programming units			MG WV
<p>Rotary controller</p> <ul style="list-style-type: none"> ■ Programming unit with clear and simple design ■ Filter change indicator ■ Wall frame ■ Connection of up to 6 Vitovent 050-D ■ Star wiring configuration 		ZK03626 117,-	Part no. Euro
<p>Programming unit</p> <ul style="list-style-type: none"> ■ Programming unit with clear structure and simple selection of all operating modes ■ Integral humidity sensor ■ Filter change indicator ■ Wall frame ■ Connection of up to 6 Vitovent 050-D ■ Star wiring configuration 		ZK02952 223,-	Part no. Euro
<p>WiFi programming unit</p> <ul style="list-style-type: none"> ■ Control of the ventilation unit via the WiFi programming unit or via an app ■ Integral temperature, humidity and VOC sensor ■ Voice control compatible 		ZK04640 461,-	Part no. Euro
<p>Power supply unit, flush mounted</p> <ul style="list-style-type: none"> ■ Connection of up to 6 Vitovent 050-D per power supply unit ■ Star wiring configuration 		ZK02953 183,-	Part no. Euro
<p>Power supply unit, top-hat rail</p> <ul style="list-style-type: none"> ■ Connection of up to 6 Vitovent 050-D per power supply unit ■ Star wiring configuration 		ZK02954 183,-	Part no. Euro
Accessories			MG WV
<p>Sound insulation set</p> <ul style="list-style-type: none"> ■ Appliance insert with sound-absorbing effect ■ Reduction in fan noise and outside noise 		ZK02955 57,-	Part no. Euro

VITOVENT 050-D

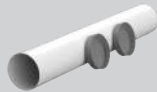
Accessories

Ventilation units (decentralised)			
Extract air fans			MG WV
For extract air areas with external walls			
Vitovent 100-D, type E200 A68 <ul style="list-style-type: none"> ■ Extract air fan, max. flow rate 68 m³/h ■ Humidity module with run-on control ■ For wall or ceiling mounting ■ Sealable internal wall cover (white) ■ Dimensions of internal wall cover <ul style="list-style-type: none"> - Width 197 mm - Height 197 mm - Depth 40 mm 		ZK02705 331,-	Part no. Euro
Vitovent 100-D, type E100 A68 <ul style="list-style-type: none"> ■ Extract air fan, max. flow rate 68 m³/h ■ Run-on control, time-based ■ For wall or ceiling mounting ■ Sealable internal wall cover (white) ■ Dimensions of internal wall cover <ul style="list-style-type: none"> - Width 197 mm - Height 197 mm - Depth 40 mm 		ZK02706 286,-	Part no. Euro
Set for unfinished walls, round wall sleeve with cap <ul style="list-style-type: none"> ■ Wall sleeve, 500 mm long ■ Ø 104 mm ■ Cap ■ Protective plugs 		ZK02717 72,-	Part no. Euro
Round wall sleeve for extract air <ul style="list-style-type: none"> ■ Ø 104 mm ■ Length 500 mm 		ZK02718 27,-	Part no. Euro
Installation element for window reveal, extract air, white <ul style="list-style-type: none"> ■ Installation element with reduction to DN 100 ■ Can be used with extract air fans, type Maico AWB 100 HC/TC ■ Unobtrusive appearance and high sound insulation against outside noise ■ External grille, reduces draughts 		7973313 337,-	Part no. Euro
Installation element for window reveal, extract air, anthracite <ul style="list-style-type: none"> ■ Installation element with reduction to DN 100 ■ Can be used with extract air fans, type Maico AWB HC/TC ■ Unobtrusive appearance and high sound insulation against outside noise ■ External grille, reduces draughts 		7973312 337,-	Part no. Euro







5.4

5472998

VITOVENT 050-D

Accessories

5.4

Ventilation units (decentralised)			
Extract air fans			MG WV
For extract air areas without external walls			
<p>Vitovent 100-D, type E300</p> <ul style="list-style-type: none"> ■ Universal extract air fan, including internal wall cover in white ■ For internal wet rooms such as a bathroom, WC or kitchen ■ Complies with the specifications of DIN 18017-3 ■ Dimensions of internal wall cover: <ul style="list-style-type: none"> - Width 260 mm - Height 260 mm - Depth 55 mm <p><i>Flush mounted enclosure and control module required</i></p>		Z017684 243,-	Part no. Euro
<p>Plastic flush mounted enclosure</p> <ul style="list-style-type: none"> ■ Flat flush mounted enclosure made from plastic ■ Connector DN 75 ■ Including plaster cover ■ Dimensions: <ul style="list-style-type: none"> - Width 270 mm - Height 270 mm - Depth 85 mm <p><i>For Vitovent 100-D, type E300 only</i></p>		ZK04629 53,-	Part no. Euro
<p>Fire safety flush mounted enclosure</p> <ul style="list-style-type: none"> ■ Flat flush mounted enclosure made from calcium silicate fire-resistant plates ■ Connector DN 75 ■ Including plaster cover ■ Dimensions: <ul style="list-style-type: none"> - Width 255 mm - Height 255 mm - Depth 85 mm <p><i>For Vitovent 100-D, type E300 only</i></p>		ZK04630 118,-	Part no. Euro
<p>Control module 1-stage, type E-N</p> <ul style="list-style-type: none"> ■ Air flow rate: 60 m³/h ■ Adjustable start delay and run-on <p><i>Suitable for use in combination with Vitovent 100-D, type H00E and Vitovent 050-D, type H20E.</i></p>		ZK04631 118,-	Part no. Euro
<p>Control module 1-stage, type E-N-F</p> <ul style="list-style-type: none"> ■ Air flow rate: 60 m³/h ■ Adjustable start delay and run-on ■ Demand-based control with humidity sensor <p><i>Suitable for use in combination with Vitovent 100-D, type H00E and Vitovent 050-D, type H20E.</i></p>		ZK04633 341,-	Part no. Euro
<p>Control module 2-stage, type E-N</p> <ul style="list-style-type: none"> ■ Air flow rate 30/60 m³/h ■ Adjustable start delay and run-on <p><i>Suitable for use as an extract air system.</i></p>		ZK04632 148,-	Part no. Euro
<p>Control module 2-stage, type E-N-F</p> <ul style="list-style-type: none"> ■ Air flow rate 30/60 m³/h ■ Adjustable start delay and run-on ■ Demand-based control with humidity sensor <p><i>Suitable for use as an extract air system.</i></p>		ZK04634 363,-	Part no. Euro
<p>Output relay</p> <ul style="list-style-type: none"> ■ For switching off the ventilation system when multiple extract air systems are operating simultaneously ■ Installation on top-hat rail in distribution panel 		ZK04636 223,-	Part no. Euro

5472998
5472008

VITOVENT 050-D

Accessories

Ventilation units (decentralised)			
Filters for Vitovent 050-D			MG WV
Filters (set) <ul style="list-style-type: none"> ■ Coarse filters ■ 4 pce 		ZK02956 43,-	Part no. Euro
Pollen filters (set) <ul style="list-style-type: none"> ■ Pollen filters ■ 4 pce 		ZK02957 77,-	Part no. Euro
Filters for Vitovent 100-D			MG WV
Filters (set) <ul style="list-style-type: none"> ■ Coarse filters ■ 5 pce <i>For type E300</i>		ZK04635 50,-	Part no. Euro

5.4

5.4

VITOVENT 100-D

Decentralised ventilation unit with heat recovery
for single rooms or apartments



Will be introduced separately. Information follows

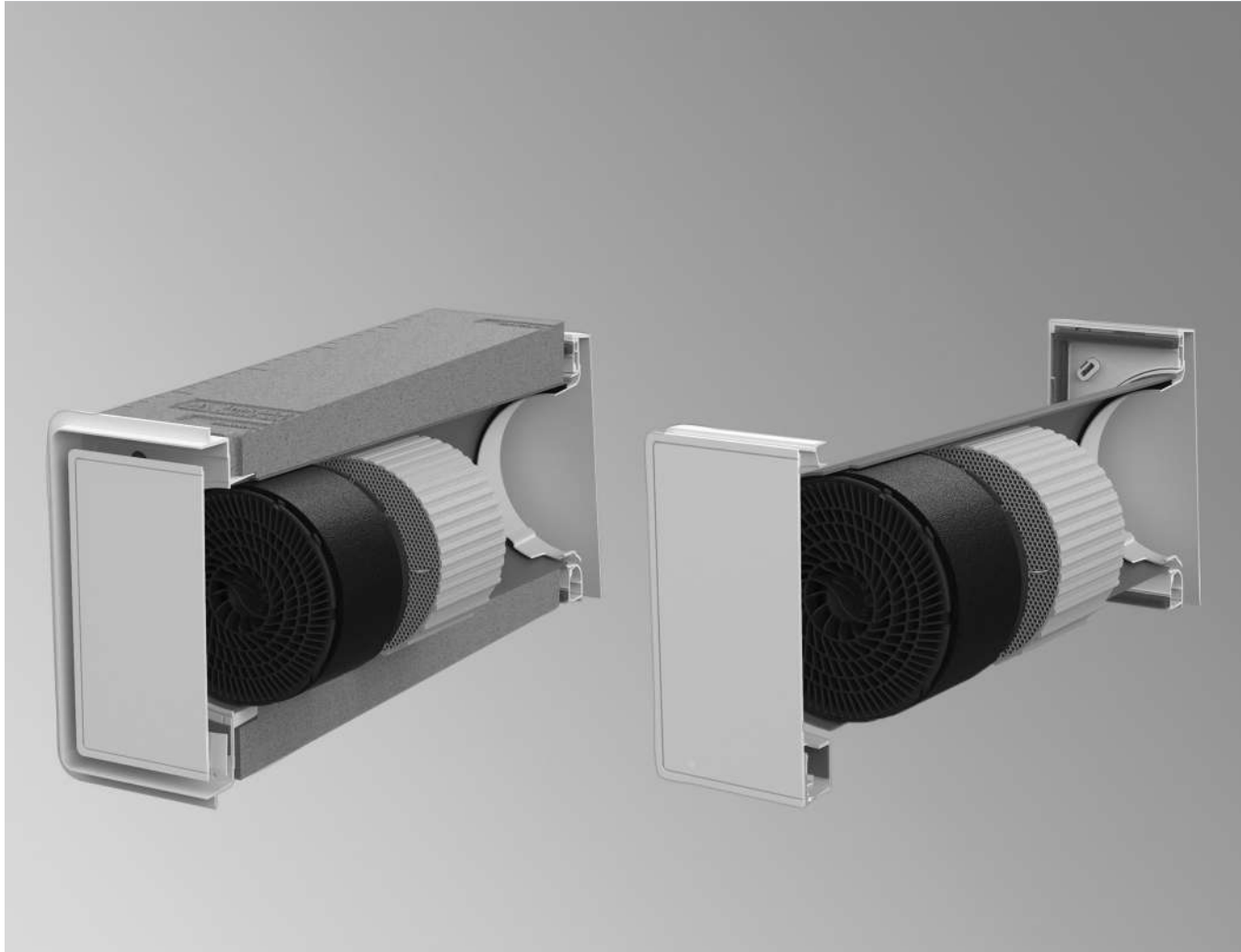

5.5

Vitovent 100-D

Type H40E B55 (L)

- Air flow rate up to 55 m³/h
- Hardwired communication via Modbus
- Star or circular wiring configuration
- 2 to 6 fans and one programming unit form one ventilation group

Type H40E B55 (F)

- Air flow rate up to 55 m³/h
- Wireless communication between appliances and programming unit using wireless standard
- Up to 12 mesh subscribers possible
- 230 V connection in the cover





- Simultaneous heat recovery and humidity control via integrated, cleanable ceramic thermal stores
- Energy cost savings through heat recovery
- Reliable moisture protection without having to frequently open windows
- Internal and external wall covers optimised for noise and flow
- Straightforward operation using capacitive buttons on the programming unit or with the app and WiFi programming unit
- Airing mode for cooling on summer nights
- Easy installation with standard Ø 162 mm core-drilled hole
- Tool-free maintenance and cleaning from within the living space

8/2023

5472997

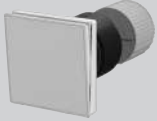
VITOVENT 100-D

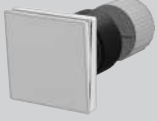







Ventilation units with heat recovery
for single rooms or apartments

Ventilation units (decentralised)			
Main product			
Type	(L)	(F)	MG WV
Vitovent 100-D, type H40E B55 (L) <ul style="list-style-type: none"> 1 fan unit with 12 V connection and hardwired communication, for wall mounting Fan Thermal store Adjustable internal wall cover optimised for noise and flow (white) Filter (coarse filter) <i>A wall sleeve and external wall cover must also be ordered.</i> 	Z026512 609,- - - <A+ -	-	Part no. Euro 
Vitovent 100-D, type H40E B55 (F) <ul style="list-style-type: none"> 1 fan unit with 230 V connection and wireless communication, for wall mounting Fan Thermal store Adjustable internal wall cover optimised for noise and flow (white) Filter (coarse filter) <i>A wall sleeve and external wall cover must also be ordered.</i> 	-	Z026513 775,- - <A <A+ <A+	Part no. Euro 
Specification			
Air flow rate <ul style="list-style-type: none"> Stage 1 Stage 2 Stage 3 Stage 4 		17 28 39 55	m³/h m³/h m³/h m³/h
Heat recovery level (Heat recovery and humidity control)		Up to 91	%
IP rating		IP 40	
Minimum diameter of core-drilled hole		162	mm
Dimensions of internal wall cover <ul style="list-style-type: none"> Width Height Depth 		218 218 32.8	mm mm mm

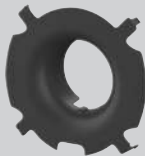
5.5

VITOVENT 100-D

Accessories



Accessories			
Covers & wall sleeves			MG WV
External wall cover, white <ul style="list-style-type: none"> External wall cover optimised for noise and flow Can be screwed directly onto the external wall Reduces draughts Optimised draining of condensate 		7973308 283,-	Part no. Euro
External wall cover, anthracite <ul style="list-style-type: none"> External wall cover optimised for noise and flow Can be screwed directly onto the external wall Reduces draughts Optimised draining of condensate 		7973307 283,-	Part no. Euro
Plug-in adaptor for external wall cover DN 160 For use with white or anthracite external wall cover <ul style="list-style-type: none"> For insertion into the wall sleeve 		7973303 42,-	Part no. Euro
Plug-in adaptor for external wall cover DN 100 Can be used for combinations consisting of 100-D external wall covers and extract air fan, type Maico AWB 100 HC/TC <ul style="list-style-type: none"> For insertion into the wall sleeve 		7973304 42,-	Part no. Euro
Design stainless steel external wall cover <ul style="list-style-type: none"> External wall cover (stainless steel), reduces draughts 		ZK03629 311,-	Part no. Euro
Stainless steel external wall cover <ul style="list-style-type: none"> External wall cover (stainless steel), reduces draughts 		ZK04639 296,-	Part no. Euro
Installation element for window reveal, white <ul style="list-style-type: none"> Unobtrusive appearance and high sound insulation against outside noise External grille, reduces draughts 		7973310 337,-	Part no. Euro
Installation element for window reveal, anthracite <ul style="list-style-type: none"> Unobtrusive appearance and high sound insulation against outside noise External grille, reduces draughts 		7973309 337,-	Part no. Euro
Round wall sleeve <ul style="list-style-type: none"> 500 mm long (can be trimmed to size) Ø 160 mm Protective plugs 		ZK02707 77,-	Part no. Euro

5.5

5472997

VITOVENT 100-D

Accessories

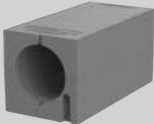
Accessories			
Covers & wall sleeves			MG WV
Round wall sleeve <ul style="list-style-type: none"> ■ 700 mm long (can be trimmed to size) ■ Ø 160 mm ■ Protective plugs 		ZK02708 93,-	Part no. Euro
Flush mounted frame 100-D <ul style="list-style-type: none"> ■ Installation of the internal wall cover flush with the wall ■ Only in conjunction with square installation set 		7973299 85,-	Part no. Euro
Square installation set <ul style="list-style-type: none"> ■ Installation block to enclose the round wall sleeve with external wall cover ■ 3 % fall for secure installation ■ Material: Neopor 		7973305 93,-	Part no. Euro









5.5

Please note:

For installation of the Vitovent, a wall sleeve **and** an external wall cover or the installation element for the window reveal must also be ordered.

VITOVENT 100-D

Accessories



Accessories			
Wireless programming units and accessories			MG WV
<p>Programming unit for 100-D wireless</p> <ul style="list-style-type: none"> Individual control of up to 12 mesh subscribers Convenient touch operation with sleep and airing modes Programming unit Wall frame Controller with power supply unit for flush mounting 		7973317 325,-	Part no. Euro
<p>Pressure and indoor air quality sensor</p> <ul style="list-style-type: none"> Enables fully automatic control of a zone based on the measured indoor air quality (pressure differential, temperature, humidity, VOCs) Simply plug-in principle Automatic detection <p><i>Zone-by-zone control requires a programming unit for each zone</i></p>		7973412 190,-	Part no. Euro
<p>Programming unit battery for 100-D wireless</p> <ul style="list-style-type: none"> Individual control of up to 12 mesh subscribers Convenient touch operation with sleep and airing modes Programming unit Wall frame Controller with battery case for operation independent of location 		7973318 213,-	Part no. Euro
<p>WiFi programming unit for 100-D wireless</p> <ul style="list-style-type: none"> Individual control of up to 12 mesh subscribers Control of the ventilation system via the WiFi programming unit or via an app Integral temperature, humidity and VOC sensor Voice control compatible Programming unit Wall frame 		7973316 552,-	Part no. Euro
Wired programming units and accessories			MG WV
<p>Programming unit for 100-D wired</p> <ul style="list-style-type: none"> Individual control of up to 3 ventilation groups Max. number of units depends on the number of power supply units Convenient touch operation with sleep and airing modes Filter change indicator Programming unit Wall frame Ring or star wiring configuration 		7973320 213,-	Part no. Euro
<p>WiFi programming unit for 100-D wired</p> <ul style="list-style-type: none"> Individual control of up to 3 ventilation groups Control of the ventilation unit via the WiFi programming unit or via an app Integral temperature, humidity and VOC sensor Voice control compatible Programming unit Wall frame 		7973319 514,-	Part no. Euro
<p>Power supply unit, top-hat rail</p> <ul style="list-style-type: none"> Supplies up to 6 Vitovent 100-D type H40E B55 (L) 12 V power supply 		7973415 177,-	Part no. Euro
<p>Power supply unit, flush mounted</p> <ul style="list-style-type: none"> Each power supply unit supplies up to 6 Vitovent 100-D type H40E B55 (L) 12 V power supply 		7973416 177,-	Part no. Euro

5.5

5472997

VITOVENT 100-D

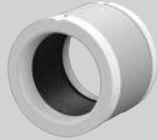





Accessories

Accessories				
Accessories Silencer 125 mm <ul style="list-style-type: none"> ■ Appliance insert with sound-absorbing effect ■ Reduction in fan noise and outside noise 			7973314 96,-	MG WV Part no. Euro
Silencer for window reveal version <ul style="list-style-type: none"> ■ Insert with sound-absorbing effect for window reveal element ■ Reduction of outside noise 				7973311 165,-

5.5

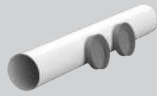
VITOVENT 100-D

Accessories







Accessories			
Extract air fans			MG WV
For extract air areas with external walls			
Vitovent 100-D, type E200 A68 <ul style="list-style-type: none"> ■ Extract air fan, max. flow rate 68 m³/h ■ Humidity module with run-on control ■ For wall or ceiling mounting ■ Sealable internal wall cover (white) ■ Dimensions of internal wall cover <ul style="list-style-type: none"> - Width 197 mm - Height 197 mm - Depth 40 mm 		ZK02705 331,-	Part no. Euro
Vitovent 100-D, type E100 A68 <ul style="list-style-type: none"> ■ Extract air fan, max. flow rate 68 m³/h ■ Run-on control, time-based ■ For wall or ceiling mounting ■ Sealable internal wall cover (white) ■ Dimensions of internal wall cover <ul style="list-style-type: none"> - Width 197 mm - Height 197 mm - Depth 40 mm 		ZK02706 286,-	Part no. Euro
Round wall sleeve for extract air <ul style="list-style-type: none"> ■ Ø 104 mm ■ Length 500 mm 		ZK02718 27,-	Part no. Euro
Round wall sleeve for extract air <ul style="list-style-type: none"> ■ Ø 104 mm ■ Length 700 mm 		7973411 85,-	Part no. Euro
Installation element for window reveal, extract air, white <ul style="list-style-type: none"> ■ Installation element with reduction to DN 100 ■ Can be used with extract air fans, type Maico AWB 100 HC/TC ■ Unobtrusive appearance and high sound insulation against outside noise ■ External grille, reduces draughts 		7973313 337,-	Part no. Euro
Installation element for window reveal, extract air, anthracite <ul style="list-style-type: none"> ■ Installation element with reduction to DN 100 ■ Can be used with extract air fans, type Maico AWB HC/TC ■ Unobtrusive appearance and high sound insulation against outside noise ■ External grille, reduces draughts 		7973312 337,-	Part no. Euro

5.5

VITOVENT 100-D

Accessories

5.5

Accessories			
Extract air fans			MG WV
For extract air areas without external walls			
<p>Vitovent 100-D, type E300</p> <ul style="list-style-type: none"> ■ Universal extract air fan, including internal wall cover in white ■ For internal wet rooms such as a bathroom, WC or kitchen ■ Complies with the specifications of DIN 18017-3 ■ Dimensions of internal wall cover: <ul style="list-style-type: none"> - Width 260 mm - Height 260 mm - Depth 55 mm <p><i>Flush mounted enclosure and control module required</i></p>		<p>Z017684 243,-</p> <p>Part no. Euro</p>	
<p>Plastic flush mounted enclosure</p> <ul style="list-style-type: none"> ■ Flat flush mounted enclosure made from plastic ■ Connector DN 75 ■ Including plaster cover ■ Dimensions: <ul style="list-style-type: none"> - Width 270 mm - Height 270 mm - Depth 85 mm <p><i>For Vitovent 100-D, type E300 only</i></p>		<p>ZK04629 53,-</p> <p>Part no. Euro</p>	
<p>Fire safety flush mounted enclosure</p> <ul style="list-style-type: none"> ■ Flat flush mounted enclosure made from calcium silicate fire-resistant plates ■ Connector DN 75 ■ Including plaster cover ■ Dimensions: <ul style="list-style-type: none"> - Width 255 mm - Height 255 mm - Depth 85 mm <p><i>For Vitovent 100-D, type E300 only</i></p>		<p>ZK04630 118,-</p> <p>Part no. Euro</p>	
<p>Control module 1-stage, type E-N</p> <ul style="list-style-type: none"> ■ Air flow rate: 60 m³/h ■ Adjustable start delay and run-on <p><i>Suitable for use in combination with Vitovent 100-D, type H00E and Vitovent 050-D, type H20E.</i></p>		<p>ZK04631 118,-</p> <p>Part no. Euro</p>	
<p>Control module 1-stage, type E-N-F</p> <ul style="list-style-type: none"> ■ Air flow rate: 60 m³/h ■ Adjustable start delay and run-on ■ Demand-based control with humidity sensor <p><i>Suitable for use in combination with Vitovent 100-D, type H00E and Vitovent 050-D, type H20E.</i></p>		<p>ZK04633 341,-</p> <p>Part no. Euro</p>	
<p>Control module 2-stage, type E-N</p> <ul style="list-style-type: none"> ■ Air flow rate 30/60 m³/h ■ Adjustable start delay and run-on <p><i>Suitable for use as an extract air system.</i></p>		<p>ZK04632 148,-</p> <p>Part no. Euro</p>	
<p>Control module 2-stage, type E-N-F</p> <ul style="list-style-type: none"> ■ Air flow rate 30/60 m³/h ■ Adjustable start delay and run-on ■ Demand-based control with humidity sensor <p><i>Suitable for use as an extract air system.</i></p>		<p>ZK04634 363,-</p> <p>Part no. Euro</p>	
<p>Output relay</p> <ul style="list-style-type: none"> ■ For switching off the ventilation system when multiple extract air systems are operating simultaneously ■ Installation on top-hat rail in distribution panel 		<p>ZK04636 223,-</p> <p>Part no. Euro</p>	

5472997
5472007

VITOVENT 100-D

Accessories

Accessories			
Filters for Vitovent 100-D			MG WV
Dust filter set Set contains 4 dust filters <i>Filters are only compatible with Vitovent 100-D type H40E B55 (L)/(F)</i>		7973300 48,-	Part no. Euro
Filters (set) ■ Coarse filters ■ 5 pce <i>For type E300</i>		ZK04635 50,-	Part no. Euro

5.5

5.5

VITOVENT 200-D

Decentralised ventilation unit with heat recovery
For single rooms or apartments



5.6

Vitovent 200-D

Type HR B55

- Air flow rate up to 55 m³/h with integral control unit and 4 operating modes

Type HRM B55

- Air flow rate up to 55 m³/h with integral control unit and 7 operating modes
- Prepared for automatic operation in conjunction with air quality sensor (accessories)
- Integral wireless receiver for connecting the wireless operating switch (accessories)

- Continuous operation ensures comfortable room temperatures.
- Balanced humidity management prevents building damage.
- Easy installation in the external wall without air ducts – ideal for modernisation and retrofitting
- Wall sleeves for unfinished walls make for easier installation of the ventilation unit later.
- Closed windows improve security against burglary and protect against noise.
- Filtered outdoor air – ideal for allergy sufferers
- Quiet power saving fans
- Reduced heat losses in fresh air supply thanks to high level of heat recovery from extract air, which helps to lower heating bills.
- Integral control unit for straightforward operation
- Installation only requires a 230 V power supply – no need to set up the unit.

4/2023

5812373

VITOVENT 200-D

Ventilation units with heat recovery
For single rooms or apartments

Ventilation units (decentralised)

Ventilation units

Vitovent 200-D, type HR B55

Decentralised ventilation unit with heat recovery, air flow rate up to 55 m³/h

- For individual rooms up to approx. 25 m²
- Heat recovery level up to 90 %
- Integral control unit with 4 selectable presets for flow rate:
 - Background ventilation
 - Reduced ventilation
 - Standard ventilation
 - Intensive ventilation
- Integral frost protection function
- Supply air filter F7, extract air filter G4
- Dimensions of internal wall cover (colour: White)
 - Width 340 mm
 - Height 340 mm
 - Depth 70 mm



Z014592

955,-

◀ B

-

-

-

MG WV

Part no.
Euro



For installation, please also order a wall sleeve; see "Accessories".

5.6

Vitovent 200-D, type HRM B55

Decentralised ventilation unit with heat recovery, air flow rate up to 55 m³/h

- For individual rooms up to approx. 25 m²
- Heat recovery level up to 90 %
- Integral control unit with 7 operating modes:
 - Background ventilation
 - Reduced ventilation
 - Standard ventilation
 - Intensive ventilation
 - Supply air mode
 - Extract air mode
 - Automatic mode (air quality sensor required, see Accessories)
- Integral wireless receiver for using a wireless operating switch
- Integral frost protection function
- Supply air filter F7, extract air filter G4
- Dimensions of internal wall cover (colour: White)
 - Width 340 mm
 - Height 340 mm
 - Depth 70 mm



Z014593

1.141,-

◀ B

-

-

◀ A



Part no.
Euro



For installation, please also order a wall sleeve; see "Accessories".

VITOVENT 200-D

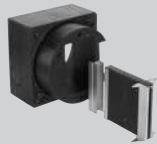

Accessories

Ventilation units (decentralised)			
Wall sleeves			MG WV
Wall sleeve, round, with external wall cover <ul style="list-style-type: none"> ■ For installing the ventilation unit inside a circular wall opening (min. Ø 320 mm) ■ For wall thicknesses from 320 to 530 mm ■ Separate installation of wall sleeve and ventilation unit is possible ■ UV-resistant external wall cover with drip edge for condensate 		Z012505 862,- Part no. Euro	
Wall sleeve, square, with external wall cover <ul style="list-style-type: none"> ■ For installing the ventilation unit inside a square wall opening (min. 325 x 325 mm) ■ For a wall thickness from 320 to 480 mm; optional extension ■ Separate installation of wall sleeve and ventilation unit is possible ■ UV-resistant external wall cover with drip edge for condensate 		Z014596 442,- Part no. Euro	
Wall sleeve, square, with external wall cover and air duct connection <ul style="list-style-type: none"> ■ For installing the ventilation unit inside a square wall opening (min. 325 x 325 mm) ■ For a wall thickness from 420 to 480 mm; optional extension <ul style="list-style-type: none"> - Extract air and supply air directions are not interchangeable - Supply air (indoors) right-hand side - Extract air (indoors) left-hand side ■ Separate installation of wall sleeve and ventilation unit is possible ■ UV-resistant external wall cover with drip edge for condensate ■ Optional connection of up to 2 air ducts DA 75 (max. 10 m per duct) <i>Duct must also be ordered, see price sheet for air distribution system.</i>		Z014595 678,- Part no. Euro	
Extension for square wall sleeve For wall thicknesses from 480 to 640 mm		7201532 316,- Part no. Euro	
Spacers for square wall sleeve <ul style="list-style-type: none"> ■ 5 pce in set ■ To adjust the position of the square wall sleeve outwards by 1 cm per spacer 		ZK02579 48,- Part no. Euro	
Appliance spacers, round <ul style="list-style-type: none"> ■ 5 pce in set ■ To adjust the position of the "Extensions for round/rectangular wall sleeve" inwards 		ZK02580 43,- Part no. Euro	
Cover frame for square wall sleeve Trimmable push-in frame (polystyrene) for covering the "square wall sleeve" indoors. The cover frame can be papered over or painted.		ZK02578 83,- Part no. Euro	

5.6

Notes:

For installation of the Vitovent, a wall sleeve **and** an external wall cover or the installation element for the window reveal must also be ordered.

Accessories			MG WV
Wireless operating switch <ul style="list-style-type: none"> ■ Wireless operating switch with frame, for mounting on a wall with adhesive or screws ■ For setting the operating modes of the ventilation unit ■ Maintenance-free operation without power supply or batteries ■ Operation of one ventilation unit with up to 5 wireless operating switches ■ Operation of up to 10 ventilation units with 1 wireless operating switch 		ZK02582 313,- Part no. Euro	
Air quality sensor <ul style="list-style-type: none"> ■ For automatic control of the air flow rate subject to air quality ■ Determination of air quality by capturing the concentration of CO₂ and other mixed gases as well as the relative humidity ■ Hidden installation inside the internal wall cover of the ventilation unit ■ Enables "local demand control" 		ZK02583 446,- Part no. Euro	

VITOVENT 200-D

Accessories

Ventilation units (decentralised)

Filter for Vitovent 200-D

Supply air and extract air filter set

- Set for 1 filter change
- 1 supply air filter F7
 - 1 extract air filter G4



7201529
38,-

MG WV
Part no.
Euro

5.6

Supply and extract air filters for mechanical ventilation units



Filters for Vitoair FS

ViPure fine filter set for ventilation unit

Set for 1 filter change

- 1 supply air filter F7 / ISO ePM1 50 %
- 1 extract air filter G4 / ISO Coarse 60 %



7372093
77,-

MG WV
Part no.
Euro

ViPure coarse filter set for ventilation unit

Set for 1 filter change

- 1 supply air filter G4 / ISO Coarse 60 %
- 1 extract air filter G4 / ISO Coarse 60 %



7372082
69,-

Part no.
Euro

Filters for Vitovent 300

ViPure coarse filter set for ventilation unit

Set for 1 filter change

- 1 supply air filter G4 / ISO Coarse 65 %
- 1 extract air filter G4 / ISO Coarse 65 %

For **Vitovent 300** (180 m³/h, serial no. 7373372 and 3004500)



7501792
37,-

MG WV
Part no.
Euro

ViPure fine filter set for ventilation unit

Set for 1 filter change

- 1 supply air filter F7 / ISO ePM1 70 %
- 1 extract air filter G4 / ISO Coarse 65 %

For **Vitovent 300** (180 m³/h, serial no. 7373372)



7501790
78,-

Part no.
Euro

ViPure coarse filter set for ventilation unit

Set for 1 filter change

- 2 supply air filter G4 / ISO Coarse 65 %
- 1 extract air filter G4 / ISO Coarse 65 %

For **Vitovent 300** (300 and 400 m³/h, serial no. 7373373 and 7373374)



7501793
51,-

Part no.
Euro

ViPure fine filter set for ventilation unit

Set for 1 filter change

- 2 supply air filter F7 / ISO ePM1 70 %
- 1 extract air filter G4 / ISO Coarse 65 %

For **Vitovent 300** (300 and 400 m³/h, serial no. 7373373 and 7373374)



7501791
138,-

Part no.
Euro

Filter set for ventilation unit

Sets for 3 filter changes

- 3 supply air filters F6 (498 x 238 x 19 mm)
- 3 extract air filters G4 (498 x 238 x 19 mm)

For **Vitovent 300** (260 m³/h, serial no. 3002017 and 3002018)



7143771
201,-

Part no.
Euro

Filters for Vitovent 300-W

ViPure fine filter set for ventilation unit

Set for 1 filter change

- 1 supply air filter F7 / ISO ePM1 70 %
- 1 extract air filter G4 / ISO Coarse 65 %

For **Vitovent 200-W** (type H22S A300, serial no. 7571124)

For **Vitovent 300-W** (type HR A300 and HR A400, serial no. 7521193 and 7521194 and type H32S B300 and H32S B400, serial no. 7571089 and 7571090)



7521198
88,-

MG WV
Part no.
Euro

ViPure fine filter set for ventilation unit with enthalpy heat exchanger

Set for 1 filter change

- 1 supply air filter F7 / ISO ePM1 70 %
- 1 extract air filter M5 / ISO ePM10 50 %

For **Vitovent 200-W** (type H22S A300, serial no. 7571124)

For **Vitovent 300-W** (type H32E B300 and B400, serial no. 7571106 and 7571107)



ZK02576
88,-

Part no.
Euro

5.7



4/2023

5812374

Supply and extract air filters





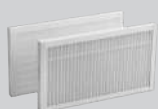
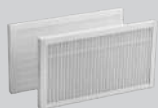

for mechanical ventilation units

5.7

Supply and extract air filters for mechanical ventilation units			
Filters for Vitovent 300-W			MG WV
<p>ViPure coarse filter set for ventilation unit Set for 1 filter change</p> <ul style="list-style-type: none"> ■ 1 supply air filter G4 / ISO Coarse 65 % ■ 1 extract air filter G4 / ISO Coarse 65 % <p>For Vitovent 200-W (type H22S A300, serial no. 7571124) For Vitovent 300-W (type HR A300 and HR A400, serial no. 7521193 and 7521194 and type H32S B300 and H32S B400, serial no. 7571089 and 7571090)</p>		7521197 55,-	Part no. Euro
Filters for Vitovent 300-W			MG WV
<p>ViPure fine filter set for ventilation unit Set for 1 filter change</p> <ul style="list-style-type: none"> ■ 1 supply air filter F7 / ISO ePM1 50 % ■ 1 extract air filter G4 / ISO Coarse 60 % <p>For Vitovent 300-W (type H32S A225 (R/L), serial no. 7372809 and 7372810)</p>		ZK05956 77,-	Part no. Euro
<p>ViPure coarse filter set for ventilation unit Set for 1 filter change</p> <ul style="list-style-type: none"> ■ 1 supply air filter G4 / ISO Coarse 60 % ■ 1 extract air filter G4 / ISO Coarse 60 % <p>For Vitovent 300-W (type H32S A225 (R/L), serial no. 7372809 and 7372810)</p>		ZK05957 51,-	Part no. Euro
<p>ViPure fine filter set for ventilation unit Set for 1 filter change</p> <ul style="list-style-type: none"> ■ 1 supply air filter F7 / ISO ePM1 50 % ■ 1 extract air filter F7 / ISO ePM1 50 % <p>For Vitovent 300-W (type H32S C325 and C400 (R/L) serial no. 7372260 to 7372263 and type H32E C325 and C400 (R/L) serial no. 7973372 to 7973375)</p>		ZK05288 63,-	Part no. Euro
<p>ViPure coarse filter set for ventilation unit Set for 1 filter change</p> <ul style="list-style-type: none"> ■ 1 supply air filter G4 / ISO Coarse 60 % ■ 1 extract air filter G4 / ISO Coarse 60 % <p>For Vitovent 300-W (type H32S C325 and C400 (R/L) serial no. 7372260 to 7372263 and type H32E C325 and C400 (R/L) serial no. 7973372 to 7973375)</p>		ZK05289 51,-	Part no. Euro
<p>ViPure fine filter set for ventilation unit Set for 1 filter change</p> <ul style="list-style-type: none"> ■ 1 supply air filter F7 / ISO ePM1 50 % ■ 1 extract air filter G4 / ISO Coarse 60 % <p>For Vitovent 300-W (type H32S A600 (R/L), serial no. 7973277 and 7973278)</p>		7973281 46,-	Part no. Euro
<p>ViPure coarse filter set for ventilation unit Set for 1 filter change</p> <ul style="list-style-type: none"> ■ 1 supply air filter G4 / ISO Coarse 60 % ■ 1 extract air filter G4 / ISO Coarse 60 % <p>For Vitovent 300-W (type H32S A600 (R/L), serial no. 7973277 and 7973278)</p>		7973280 25,-	Part no. Euro
Filters for Vitovent 300-W			MG WV
<p>ViPure fine filter set for ventilation unit Set for 1 filter change</p> <ul style="list-style-type: none"> ■ 1 supply air filter F7 / ISO ePM1 50 % ■ 1 extract air filter G4 / ISO Coarse 60 % <p>For Vitovent 300-W (type H32S C325 and C400 (R/L) serial no. 7372260 to 7372263) For Vitovent 200-P (all serial numbers)</p>		ZK05287 77,-	Part no. Euro

5812374
5812374





Supply and extract air filters for mechanical ventilation units

Supply and extract air filters for mechanical ventilation units			
Filters for Vitovent 050-D			MG WV
Filters (set) <ul style="list-style-type: none"> ■ Coarse filters ■ 4 pce For Vitovent 050-D (type H20E A43, serial no. 7638945)		ZK02956 43,-	Part no. Euro
Pollen filters (set) <ul style="list-style-type: none"> ■ Pollen filters ■ 4 pce For Vitovent 050-D (type H20E A43, serial no. 7638945)		ZK02957 77,-	Part no. Euro
Filters for Vitovent 100-D			MG WV
Filters (set) <ul style="list-style-type: none"> ■ Coarse filters ■ 4 pce For Vitovent 100-D (type H00E A45, serial no. 7571848)		ZK02715 43,-	Part no. Euro
Pollen filters (set) <ul style="list-style-type: none"> ■ Pollen filters ■ 4 pce For Vitovent 100-D (type H00E A45, serial no. 7571848)		ZK02716 77,-	Part no. Euro
Filters (set) <ul style="list-style-type: none"> ■ Coarse filters ■ 5 pce For Vitovent 100-D (type E300, serial no. 7690647)		ZK04635 50,-	Part no. Euro
Dust filter set Set contains 4 dust filters For Vitovent 100-D (type H40E B55 (L)/(F), serial no. 7973413 and 7973410)		7973300 48,-	Part no. Euro
Filters for Vitovent 200-D			MG WV
Supply air and extract air filter set Set for 1 filter change <ul style="list-style-type: none"> ■ 1 supply air filter F7 ■ 1 extract air filter G4 For Vitovent 200-D (type HR A55, HRM A55, HR B55, HRM B55 and HRV B55, serial no. 7201527, 7201528, 7571223, 7571224 and 7571225)		7201529 38,-	Part no. Euro

5.7

Supply and extract air filters

for mechanical ventilation units

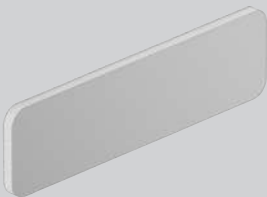
Supply and extract air filters for mechanical ventilation units			
Supply air and extract air filters			MG WV
Replacement filters <ul style="list-style-type: none"> ■ F7 pocket filter for outdoor air filter box ■ 2 pce 		7173846 151,-	Part no. Euro
Filters for extract air vents			MG WV
Extract air filters (G3) <ul style="list-style-type: none"> ■ For metal extract air vent DN 100 ■ 5 pce 		9562052 73,-	Part no. Euro
Extract air filters (G4) <ul style="list-style-type: none"> ■ For extract air vent DN 125 (part no. ZK04570 and ZK04571) and wall/ceiling air diffuser (design, part no. ZK03038) ■ 5 pce 		ZK01881 38,-	Part no. Euro
Filters for wall/ceiling air diffuser <ul style="list-style-type: none"> ■ For air diffuser (part no. ZK01855) ■ 5 pce 		ZK01882 38,-	Part no. Euro
Extract air filter, rectangular <ul style="list-style-type: none"> ■ Extract air filter for rectangular air diffuser ■ ISO Coarse ≥ 45 % (G4) ■ 5 pce 		7973065 22,-	Part no. Euro
Filters for kitchen extract air vent For kitchen extract air vent part no. 7440231		ZK02531 55,-	Part no. Euro

Please note:

Filter classification details are based on EN 779:2012 and EN 16890:2016.

5.7